

TEST REPORT

Product Name : DataHub
Model Number : DataHub1000

Prepared for : SOLAX POWER NETWORK TECHNOLOGY (ZHEJIANG)
CO., LTD.

Address : No.288, Shizhu Road, Tonglu Economic Development
Zone, Tonglu City, Zhejiang Province 310000, P. R. China

Prepared by : EMTEK (NINGBO) CO., LTD.
Address : 1F Building 4, 1177#, Lingyun Road, Ningbo National
Hi-Tech Zone, Ningbo, Zhejiang, China.

Tel: +86-574-27907998
Fax: +86-574-27721538

Report Number : ENB2204290281E00601R
Date(s) of Tests : November 25, 2021 to June 15, 2022
Date of issue : June 27, 2022



TABLE OF CONTENT

Test Report Description	Page
1. DESCRIPTION OF STANDARDS AND RESULTS (EUT)	6
2. GENERAL INFORMATION	7
2.1. Description of Device (EUT)	7
2.2. Input / Output Ports.....	8
2.3. Independent Operation Modes	8
2.4. Test Manner	9
2.5. Description of Support Device	9
2.6. Description of Test Facility	10
2.7. Test Software	10
2.8. Measurement Uncertainty.....	11
3. MEASURING DEVICE AND TEST EQUIPMENT	12
3.1. For Power Line Conducted Emission Measurement.....	12
3.2. For Conducted Emissions at Telecommunications/network port Measurement.....	12
3.3. For Radiated Emission Measurement (Up to 1 GHz).....	12
3.4. For Radiated Emission Measurement (Above 1 GHz)	13
3.5. For Harmonic Current/Flicker Measurement	13
3.6. For Electrostatic Discharge Immunity Test	13
3.7. For RF Strength Susceptibility Test	14
3.8. For Electrical Fast Transient /Burst Immunity Test	14
3.9. For Surge Immunity Test.....	15
3.10. For Injected Current Susceptibility Test	15
3.11. For Voltage Dips and Interruptions Test.....	15
4. CONDUCTED EMISSIONS FROM THE AC MAINS POWER PORTS	16
4.1. Block Diagram of Test Setup	16
4.2. Limits.....	16
4.3. Test Procedure.....	16
4.4. Measuring Results	17
5. ASYMMETRIC MODE CONDUCTED EMISSIONS AT WIRED NETWORK PORTS	26
5.1. Block Diagram of Test Setup	26
5.2. Limits.....	26
5.3. Test Procedure.....	26
5.4. Measuring Results	27
6. RADIATED EMISSION MEASUREMENT (UP TO 1GHZ)	32
6.1. Block Diagram of Test Setup	32
6.2. Radiated Limit.....	32
6.3. Test Procedure.....	32
6.4. Measuring Results	33
7. RADIATED EMISSION MEASUREMENT (ABOVE 1GHZ)	42
7.1. Block Diagram of Test Setup	42
7.2. Radiated Limit.....	42
7.3. Test Procedure.....	43
7.4. Measuring Results	43
8. HARMONIC CURRENT EMISSION MEASUREMENT	49
8.1. Block Diagram of Test Setup	49
8.2. Standard Limits	49
8.3. Test Procedure.....	50
8.4. Test Results	50
9. VOLTAGE FLUCTUATION AND FLICKER MEASUREMENT	57
9.1. Block Diagram of Test Setup	57

9.2. Standard Limits	57
9.3. Test Procedure.....	57
9.4. Test Results	57
10. IMMUNITY GENERAL PERFORMANCE CRITERIA DESCRIPTION	60
11. ELECTROSTATIC DISCHARGE	61
11.1. Test Specification	61
11.2. Block Diagram of Test Setup	61
11.3. Test Procedure.....	61
11.4. Test Results	62
12. CONTINUOUS RF ELECTROMAGNETIC FIELD DISTURBANCES.....	64
12.1. Test Specification	64
12.2. Block Diagram of Test Setup	64
12.3. Test procedure	64
12.4. Test results	65
13. ELECTRICAL FAST TRANSIENTS/BURST	67
13.1. Test Specification	67
13.2. Block Diagram of Test Setup	67
13.3. Test Procedure.....	68
13.4. Test Results	68
14. SURGES	70
14.1. Test Specification	70
14.2. Block Diagram of Test Setup	70
14.3. Test Procedure.....	70
14.4. Test results	71
15. CONTINUOUS INDUCED RF DISTURBANCES	73
15.1. Test Specification	73
15.2. Block Diagram of Test Setup	73
15.3. Test Procedure.....	73
15.4. Test results	74
16. POWER FREQUENCY MAGNETIC FIELD.....	76
16.1. Test Specification	76
16.2. Block Diagram of Test Setup	76
16.3. Test Procedure.....	76
16.4. Test Results	76
17. VOLTAGE DIPS AND INTERRUPTIONS	77
17.1. Test Specification	77
17.2. Block Diagram of Test Setup	77
17.3. Test Procedure.....	77
17.4. Test results	78
18. PHOTOGRAPHS	80
18.1. Photo of Conducted Emission Measurement	80
18.2. Photo of Conducted Emissions at Telecommunications/network port Measurement.....	81
18.3. Photo of Radiation Emission Measurement (Up to 1GHz)	82
18.4. Photo of Radiation Emission Measurement (Above 1GHz).....	83
18.5. Photo of Harmonic and Flicker Measurement	84
18.6. Photo of Electrostatic Discharge Test	84
18.7. Photo of RF Field Strength Susceptibility Test.....	85
18.8. Photo of Electrical Fast Transient /Burst Test.....	85
18.9. Photo of Surge Test	86
18.10. Photo of Injected Currents Susceptibility Test	86
18.11. Photo of Voltage Dips and Interruption Immunity Test.....	87

APPENDIX (Photos of the EUT) (11 Pages)

TEST REPORT DESCRIPTION

Applicant : SOLAX POWER NETWORK TECHNOLOGY (ZHEJIANG) CO., LTD.
Manufacturer : SOLAX POWER NETWORK TECHNOLOGY (ZHEJIANG) CO., LTD.
Trade Mark : SolaX Power
EUT : DataHub
Model Number : DataHub1000
Input Voltage : AC 100-240V, 50/60Hz, 24W

Measurement Procedure Used:

EN 55032:2015+A1:2020

EN IEC 61000-3-2:2019+A1:2021

EN 61000-3-3:2013/A2:2021

EN 55035:2017+A11:2020

(IEC 61000-4-2:2008, IEC 61000-4-3:2006+A1:2007+A2:2010, IEC 61000-4-4:2012,
IEC 61000-4-5:2005, IEC 61000-4-6:2008, IEC 61000-4-8:2009, IEC 61000-4-11:2004)

The device described above is tested by EMTEK (NINGBO) CO., LTD. to determine the maximum emission levels emanating from the device and the severe levels of the device can endure and its performance criterion. The measurement results are contained in this test report and EMTEK (NINGBO) CO., LTD. is assumed full of responsibility for the accuracy and completeness of these measurements. Also, this report shows that the EUT (Equipment Under Test) is technically compliant with the EN 55032, EN IEC 61000-3-2, EN 61000-3-3, EN 55035 requirements.

This report applies to above tested sample only and shall not be reproduced in part without written approval of EMTEK (NINGBO) CO., LTD.

Date of Test : November 25, 2021 to June 15, 2022

Prepared by : *June Gao*
June Gao/Engineer

Reviewer : *Ade Wang*
Ade Wang/Supervisor

Approved & Authorized Signer : *Tony Wei*
Tony Wei/Manager



Modified Information

Version	Report No.	Revision Date	Summary
	ENB2204290281E00601R	/	See Note 1

Note 1: This report is issued on the basis of report No. ENB2111250113E005. An adapter was added based on the original report, and the new adapter was tested.



1. DESCRIPTION OF STANDARDS AND RESULTS (EUT)

EMISSION				
Description of Test Item		Standard	Limits	Results
Conducted Emissions From the AC Mains Power Ports		EN 55032:2015+A1:2020	Class B	Pass
Asymmetric mode conducted emissions	Wired network ports	EN 55032:2015+A1:2020	Class B	Pass
	Optical fibre ports	EN 55032:2015+A1:2020	Class B	N/A
	Broadcast receiver tuner ports	EN 55032:2015+A1:2020	Class B	N/A
	Antenna ports	EN 55032:2015+A1:2020	Class B	N/A
Conducted differential voltage emissions	TV broadcast receiver tuner ports	EN 55032:2015+A1:2020	Class B	N/A
	RF modulator output ports	EN 55032:2015+A1:2020	Class B	N/A
	FM broadcast receiver tuner ports	EN 55032:2015+A1:2020	Class B	N/A
Radiated emissions at frequencies up to 1 GHz		EN 55032:2015+A1:2020	Class B	Pass
Radiated emissions at frequencies above 1 GHz		EN 55032:2015+A1:2020	Class B	Pass
Radiated emissions from FM receivers		EN 55032:2015+A1:2020	Table A.6	N/A
Outdoor units of home satellite receiving systems		EN 55032:2015+A1:2020	Table A.7	N/A
Harmonic Current Emissions		EN IEC 61000-3-2:2019+A1:2021	Class A	Pass
Voltage Fluctuation and Flicker		EN 61000-3-3:2013/A2:2021	Section 5	Pass
IMMUNITY(EN 55035:2017+A11:2020)				
Description of Test Item		Basic Standard	Performance Criteria	Results
Electrostatic Discharge	Enclosure ports	IEC 61000-4-2:2008	B	Pass
Continuous RF electromagnetic field disturbances	Enclosure ports	IEC 61000-4-3:2006+A1:2007+A2:2010	A	Pass
Electrical fast transients/burst	AC mains power ports	IEC61000-4-4:2012	B	Pass
	Analogue/digital data ports		B	Pass
	DC network power ports		B	N/A
Surges	AC mains power ports	IEC 61000-4-5:2005	B	Pass
	Analogue/digital data ports for unshielded symmetrical		C	Pass
	Analogue/digital data ports for coaxial or shielded		B	N/A
	DC network power ports		B	N/A
Continuous induced RF disturbances	AC mains power ports	IEC 61000-4-6:2008	A	Pass
	Analogue/digital data ports		A	Pass
	DC network power ports		A	N/A
Power frequency magnetic field	Enclosure ports	IEC 61000-4-8:2009	A	N/A
Voltage dips and interruptions	AC mains power ports	IEC 61000-4-11:2004	B,C	Pass
Broadband impulsive conducted disturbances	Analogue/digital data ports	\	N/A	N/A
Note: N/A is an abbreviation for Not Applicable.				

2. GENERAL INFORMATION

2.1. Description of Device (EUT)

EUT : DataHub

Model Number : DataHub1000

Test Voltage : AC 230V/50Hz, AC 120V/60Hz

AC Adapter 1 : M/N: ABT020120A
Input: AC 100-240V, 50/60Hz, 1.5A
Output: DC 12V, 2A, 24W

AC Adapter 2 : M/N: BSG025W-1202000A
Input: AC 100-240V, 50/60Hz, 0.6A Max
Output: DC 12V, 2A

Highest Frequency : 2480 MHz

Sample Number : ENB2111250113E005-1-1
ENB2204290281E006-1-1

Applicant : SOLAX POWER NETWORK TECHNOLOGY (ZHEJIANG) CO., LTD.

Address : No.288, Shizhu Road, Tonglu Economic Development Zone, Tonglu City,
Zhejiang Province 310000, P. R. China

Manufacturer : SOLAX POWER NETWORK TECHNOLOGY (ZHEJIANG) CO., LTD.

Address : No.288, Shizhu Road, Tonglu Economic Development Zone, Tonglu City,
Zhejiang Province 310000, P. R. China

Date of Received : November 25, 2021

Date of Test : November 25, 2021 to June 15, 2022

2.2. Input / Output Ports

Port #	Name	Type*	Cable Max. >3m	Cable Shielded	Comments
1	RS485	A/D	--	--	None
2	Net Port	A/D	--	--	None
3	TF Card	A/D	--	--	None
4	USB Port	A/D	--	--	The reserved port has not been put into actual use yet.
5	Type C	A/D	--	--	The reserved port has not been put into actual use yet.
6	Sim Port	A/D	--	--	The reserved port has not been put into actual use yet.

*Note: Use abbreviations:

AC= AC Power port

DC= DC Power port

N/E= Non-Electrical

A/D=Analogue/digital data port (signal/control port, antenna port, wired network port, broadcast receiver tuner port, optical fibre port)

2.3. Independent Operation Modes

- A. RS485+Net Port+TF Card+WIFI
- B. RS485+WIFI
- C. Net Port+WIFI
- D. TF Card+WIFI
- E. RS485+TF Card+WIFI
- F. RS485+Net Port +WIFI
- G. Net Port+TF Card+WIFI

Investigation has been done on all the possible configurations for searching the worst cases. The report shows the data for the worst Mode, Mode A

2.4. Test Manner

Test Items	Test Voltage	Operation Modes	Worst case
Conducted disturbance at mains Terminals	AC 230V/50Hz AC 120V/60Hz	Mode A	Mode A
Asymmetric mode conducted emissions	AC 230V/50Hz AC 120V/60Hz	Mode A	Mode A
Radiated emissions at frequencies up to 1 GHz	AC 230V/50Hz AC 120V/60Hz	Mode A	Mode A
Radiated emissions at frequencies above 1 GHz	AC 230V/50Hz AC 120V/60Hz	Mode A	Mode A
Harmonic Current Emissions	AC 230V/50Hz	Mode A	Mode A
Voltage Fluctuation and Flicker	AC 230V/50Hz	Mode A	Mode A
Electrostatic Discharge	AC 230V/50Hz	Mode A	Mode A
Continuous RF Electromagnetic Field Disturbances	AC 230V/50Hz	Mode A	Mode A
Electrical Fast Transient / Burst	AC 230V/50Hz	Mode A	Mode A
Surges	AC 230V/50Hz	Mode A	Mode A
Continuous induced RF disturbances	AC 230V/50Hz	Mode A	Mode A
Voltage dips and interruptions	AC 230V/50Hz AC 230V/60Hz	Mode A	Mode A

2.5. Description of Support Device

Notebook : Manufacturer: LENOVO
M/N: T430s
S/N: R9RK4YK

Notebook : Manufacturer: ASUS
M/N: FX80G
S/N: J7NRCX03D694281

Wireless router : Manufacturer: TP-LINK
M/N: TL-WR886N
S/N: 1156004013356

2.6. Description of Test Facility

Site Description

EMC Lab. A

: **Accredited by CNAS**

The Certificate Registration Number is L6666.

The Laboratory has been assessed and proved to be in compliance with CNAS-CL01:2018 (identical to ISO/IEC 17025:2017)

Accredited by FCC

Designation Number: CN1302

Test Firm Registration Number: 436491

Accredited by A2LA

The certificate is valid until May 31, 2023

Accredited by Industry Canada

The Conformity Assessment Body Identifier is CN0114

Name of Firm

: EMTEK (NINGBO) CO., LTD.

Site Location

: 1F Building 4, 1177#, Lingyun Road, National Hi-Tech Zone, Ningbo, Zhejiang, China

EMC Lab. B

: **Accredited by CNAS**

The Certificate Registration Number is L2291.

The Laboratory has been assessed and proved to be in compliance with CNAS-CL01 (identical to ISO/IEC 17025:2017)

Accredited by FCC

Designation Number: CN1204

Test Firm Registration Number: 882943

Accredited by A2LA

The Certificate Number is 4321.01.

Accredited by Industry Canada

The Conformity Assessment Body Identifier is CN0008

Name of Firm

: EMTEK (SHENZHEN) CO., LTD.

Site Location

: Building 69, Majialong Industry Zone, Nanshan District, Shenzhen, Guangdong, China

2.7. Test Software

Item

Software

Conducted Emission : EZ-EMC (Ver. CON-03A1)
TS+ (Ver.4.0.0.0)

Radiated Emission : EZ-EMC (Ver. EMEC-3A1)
TS+ (Ver.4.0.0.0)

2.8. Measurement Uncertainty

Test Item	Uncertainty
Conducted Emission Uncertainty	: 2.08dB (9 k-150 kHz) 2.40dB (150 k-30 MHz)
Radiated Emission Uncertainty (3m Chamber)	: 4.06dB (Polarize: H) (30MHz-1000MHz) 4.04dB (Polarize: V) (30MHz-1000MHz) 4.82dB (Polarize: H) (1~18GHz) 4.80dB (Polarize: V) (1~18GHz)
Uncertainty for Harmonic test	: 4.16% mA
Uncertainty for Flicker test	: 0.43% V
Uncertainty for ESD Test	: 6.00% kV
Uncertainty for EFT/B Test	: 3.84% kV
Uncertainty for Surge Test	: 0.53% kV
Uncertainty for C/S Test	: 1.45dB (Using CDN Test) 2.37dB (Using EM Clamp Test)
Uncertainty for DIPS Test	: 2.12% V
Uncertainty for R/S Test	: 2.10dB(80 MHz-200 MHz) 2.36dB(200 MHz-1000 MHz) 2.57dB(1000 MHz-6000 MHz)

3. MEASURING DEVICE AND TEST EQUIPMENT

3.1. For Power Line Conducted Emission Measurement

Equ. No.	Equipment	Manufacturer	Model No.	Serial No.	Last Cal.	Cal. Interval
ENE-001	Test Receiver	Rohde & Schwarz	ESCI	101108	July 08, 2021	1 Year
ENE-003	L.I.S.N	Rohde & Schwarz	ENV216	101193	July 08, 2021	1 Year
ENE-004	L.I.S.N	Schwarzbeck	NSLK 8126	8126-462	July 08, 2021	1 Year
ENE-006	Pulse Limiter	MTS-systemtechnik	IMP-136	2611115-001-0033	July 08, 2021	1 Year
ENE-005	RF Switching unit	CD	RSU-M2	38400	July 08, 2021	1 Year

3.2. For Conducted Emissions at Telecommunications/network port Measurement

Equ. No.	Equipment	Manufacturer	Model No.	Serial No.	Last Cal.	Cal. Interval
ENE-001	Test Receiver	Rohde & Schwarz	ESCI	101108	July 08, 2021	1 Year
ENE-067	I.S.N	Tsetq	ISNT8	51926	Jan. 10, 2022	1 Year
ENE-068	I.S.N	Tsetq	ISNT8-Cat 6	50583	Jan. 10, 2022	1 Year
ENE-006	Pulse Limiter	MTS-systemtechnik	IMP-136	2611115-001-0033	July 08, 2021	1 Year
ENE-005	RF Switching unit	CD	RSU-M2	38400	July 08, 2021	1 Year

3.3. For Radiated Emission Measurement (Up to 1 GHz)

Equ. No.	Equipment	Manufacturer	Model No.	Serial No.	Last Cal.	Cal. Interval
ENE-002	Spectrum Analyzer	Rohde & Schwarz	ESCI	101107	July 08, 2021	1 Year
ENE-002	EMI Test Receiver	Rohde & Schwarz	ESCI	101107	July 08, 2021	1 Year
ENE-009	Pre-Amplifier	CD	PAP-0203	22015	July 08, 2021	1 Year
ENE-010	Bilog Antenna	Schwarzbeck	VULB9163	9163-467	July 12, 2020	2 Year
ENE-025-1	Cable	Huber + Suhner	CBL3-NN-0.5 m	101216-2140 500-2	July 08, 2021	1 Year
ENE-025-2	Cable	Huber + Suhner	CBL3-NN-3.0 m	101216-2143 000-2	July 08, 2021	1 Year
ENE-025-3	Cable	Huber + Suhner	CBL3-NN-9.0 m	101216-2149 000	July 08, 2021	1 Year

3.4. For Radiated Emission Measurement (Above 1 GHz)

Equ. No.	Equipment	Manufacturer	Model No.	Serial No.	Last Cal.	Cal. Interval
ENE-170	EXA Signal Analyzer	KEYSIGHT	N9010B	MY60242457	March 01, 2022	1 Year
ENE-090	Pre-Amplifier	Connphy Microwave Inc.	GLN-1G40G-4165-K	0319104	Nov 22, 2021	1 Year
ENE-060	Horn Antenna	Schwarzbeck	BBHA 9120	9120D-707	April 13, 2021	2 Year
ENE-101-1	Cable	SMAMSMAM	A50-0.5M	N/A	July 08, 2021	1 Year
ENE-101-2	Cable	SMAMSMAM	A50-3M	N/A	July 08, 2021	1 Year
ENE-101-4	Cable	SMAMSMAM	A50-6M	N/A	July 08, 2021	1 Year
ENE-095	Band Reject Filter	O.M.Jones, Inc.dba	BRM50702-0	G049	July 08, 2021	1 Year

3.5. For Harmonic Current/Flicker Measurement

Equ. No.	Equipment	Manufacturer	Model No.	Serial No.	Last Cal.	Cal. Interval
ENE-048	AC Power source	California Instruments	5001iX-CTS-400-413	59739	July 08, 2021	1 Year
ENE-049	Harmonic/ flicker analyzer	California Instruments	PACS-1	72795	July 08, 2021	1 Year
ENE-157	Harmonic/ flicker analyzer	PACIFIC	ECTS2-3300 Z-M18012	550128	Dec. 20, 2021	1 Year
ENE-157-1	AC Power source	PACIFIC	330AZX-CE	140250014	Dec. 20, 2021	1 Year

3.6. For Electrostatic Discharge Immunity Test

Equ. No.	Equipment	Manufacturer	Model No.	Serial No.	Last Cal.	Cal. Interval
ENE-139	ESD Tester	TESEQ	NSG 437	1732	Dec. 01, 2021	1 Year

3.7. For RF Strength Susceptibility Test

Equ. No.	Equipment	Manufacturer	Model No.	Serial No.	Last Cal.	Cal. Interval
EE-066-2	Power Amplifier	MILMEGA	AS0102-55	1018770	May 14, 2022	1 Year
EE-066-6	RF Power Meter. Dual Channel	BOONTON	4232A	10539	May 14, 2022	1 Year
EE-067	Log.-Per. Antenna	SCHWARZBECK	VULP 9118E	811	N/A	N/A
EE-218	Signal Generator	Agilent	N5181A	MY50145187	May 14, 2022	1 Year
EE-219	50ohm Diode Power Sensor	BOONTON	51011EMC	36164	May 14, 2022	1 Year
EE-220	Broad-Band Horn Antenna	SCHWARZBECK	STLP 9149	9149-227	N/A	N/A
EE-221	Field Strength Meter	DARE	RSS1006A	10I00037SN O22	May 23, 2022	1 Year
EE-222	Multi-function interface system	DARE	CTR1009B	12I00250SN O72	N/A	N/A
EE-223	Automatic switch group	DARE	RSW1004A	N/A	N/A	N/A
EE-224	Power Amplifier	MILMEGA	AS1860-50	1059346	May 14, 2022	1 Year
EE-225	Power Amplifier	MILMEGA	80RF1000-1 75	1059345	May 14, 2022	1 Year
EE-225-1	Directional Coupler	MILMEGA	DC6180AM1	0340463	May 14, 2022	1 Year
EE-115	Audio Analyzer	R&S	UPV	101473	May 14, 2022	1 Year
EE-615	Audio Test System	AUDIO PRECISION	ATS-1	41100	May 14, 2022	1 Year

3.8. For Electrical Fast Transient /Burst Immunity Test

Equ. No.	Equipment	Manufacturer	Model No.	Serial No.	Last Cal.	Cal. Interval
ENE-011	Burst Tester	HAEFELY	PEFT4010	173964	July 08, 2021	1 Year
ENE-012	Coupling Clamp	HAEFELY	IP-4A	147399	July 08, 2021	1 Year

3.9. For Surge Immunity Test

Equ. No.	Equipment	Manufacturer	Model No.	Serial No.	Last Cal.	Cal. Interval
ENE-097-1	Combination Wave Generator	HTEC	HCWG 100	204303	Dec. 20, 2021	1 Year
ENE-097-2	Three Phase Coupling/Decoupling Network	HTEC	HCOUPLER 30S	204103	Dec. 20, 2021	1 Year
ENE-097-3	High Pressure Option	HTEC	Options-10K DC	/	Dec. 20, 2021	1 Year
ENE-097-4	40 ohm Impedance	HTEC	Options-40ohm	/	Dec. 20, 2021	1 Year
ENE-097-5	10 ohm Impedance	HTEC	Options-10ohm	/	Dec. 20, 2021	1 Year
ENE-097-6	Combination Wave Generator	HTEC	HTSG 70	204304	Dec. 20, 2021	1 Year
ENE-097-7	Coupling Network	HTEC	HCN 8	204901	Dec. 20, 2021	1 Year
ENE-097-8	Decoupling Network	HTEC	HDEC 8	204902	Dec. 20, 2021	1 Year
ENE-097-9	Isolated Power Supply	HTEC	SBK-30KVA	/	Dec. 20, 2021	1 Year

3.10. For Injected Current Susceptibility Test

Equ. No.	Equipment	Manufacturer	Model No.	Serial No.	Last Cal.	Cal. Interval
ENE-057	Simulator	SCHLODER	CDG-6000-75	126B1404/2016	July 08, 2021	1 Year
ENE-058	CDN	SCHLODER	CDN-M2+3	A2210415/2016	July 08, 2021	1 Year
ENE-056	Attenuator	SCHLODER	6dB 100W	HA1615	July 08, 2021	1 Year
ENE-098	Current Injection Probe	SCHLODER	CDN BCI-P1	19102314-0101	Dec. 20, 2021	1 Year
ENE-099	EM-clamp	SCHLODER	CDN EMCL-20	20102817-0103	Dec. 20, 2021	1 Year

3.11. For Voltage Dips and Interruptions Test

Equ. No.	Equipment	Manufacturer	Model No.	Serial No.	Last Cal.	Cal. Interval
ENE-055	Dips Tester	HTEC	HPFS161P	164901	July 08, 2021	1 Year
ENE-055	AC Power source	HTEC	HV1P16T	164902	July 08, 2021	1 Year

4. CONDUCTED EMISSIONS FROM THE AC MAINS POWER PORTS

4.1. Block Diagram of Test Setup

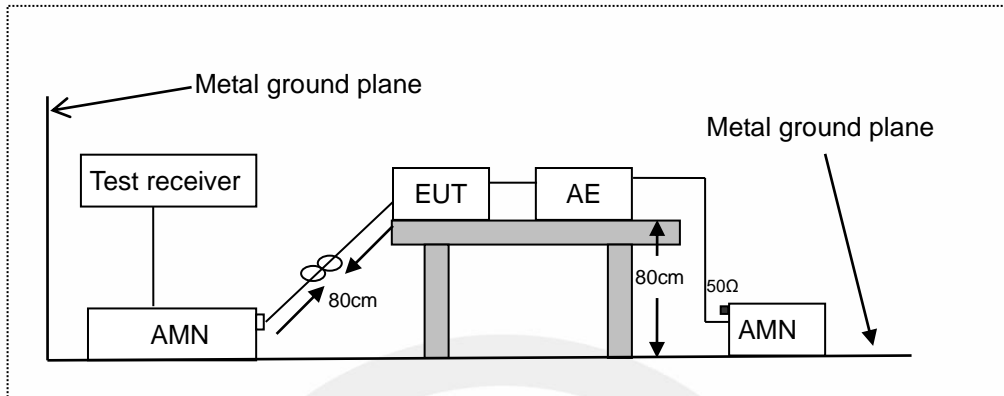

AMN: Artificial Mains Network
AE: Associated equipment
EUT: Equipment under test

4.2. Limits

EN 55032, Class B, Table A.10

Frequency range MHz	Coupling device (see Table A.8)	Detector type / bandwidth	Class B limits dB(μV)
0.15 to 0.5	AMN	Quasi Peak / 9 kHz	66 to 56
0.5 to 5			56
5 to 30			60
0.15 to 0.5	AMN	Average / 9 kHz	56 to 46
0.5 to 5			46
5 to 30			50

4.3. Test Procedure

The EUT was placed on a desk 0.8 m height from the metal ground plane and 0.4 m from the conducting wall of the shielding room and it was kept at least 0.8 m from any other grounded conducting surface. The size of the table will nominally be 1.5 m x1.0 m.

The rear of the arrangement shall be flush with the back of the supporting tabletop unless that would not be possible or typical of normal use.

All units of equipment forming the system under test (includes the EUT as well as connected peripherals and associated equipment or devices) shall be arranged such that a nominal 0.1 m separation is achieved between the neighboring units.

Connect EUT to the power mains through a artificial mains network (AMN). Where the mains cable supplied by the manufacturer is longer than 1 m, the excess should be folded at the centre into a bundle no longer than 0.4 m, so that its length is shortened to 1 m.

All the support units are connecting to the other AMN.

The AMN provides 50 ohm coupling impedance for the measuring instrument.

The CISPR states that the AMN with 50 ohm and 50 microhenry should be used.

Both sides of AC line were checked for maximum conducted interference.

The frequency range from 150 kHz to 30 MHz was sweep.

Set the test-receiver system to quasi peak detect function and average detect function, and to measure the conducted emissions values.

Test results were obtained from the following equation:

Measurement (dB μ V) = Correct Factor (dB) + Reading (dB μ V)

Over (dB) = Measurement (dB μ V) - Limit (dB μ V)

4.4. Measuring Results

Pass.

Please refer to the following pages.

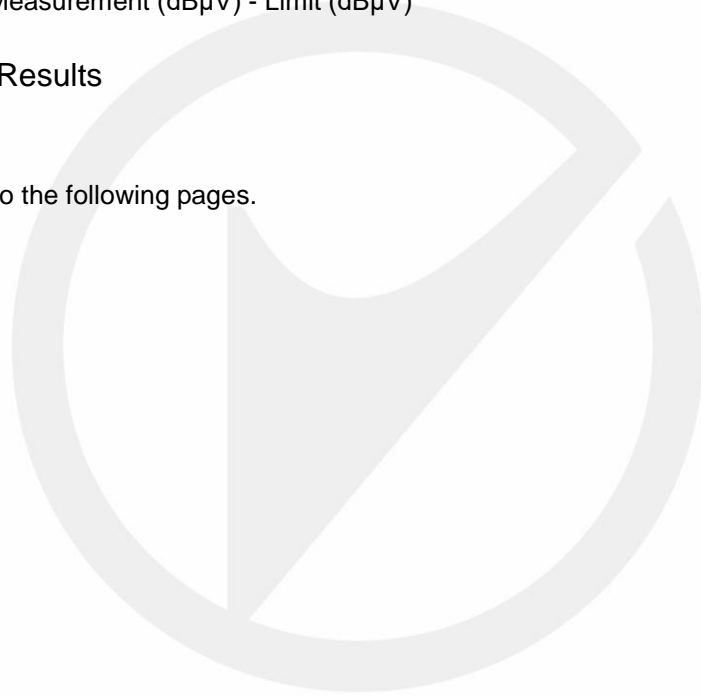

Model DataHub1000 with adapter 1 (ABT020120A)

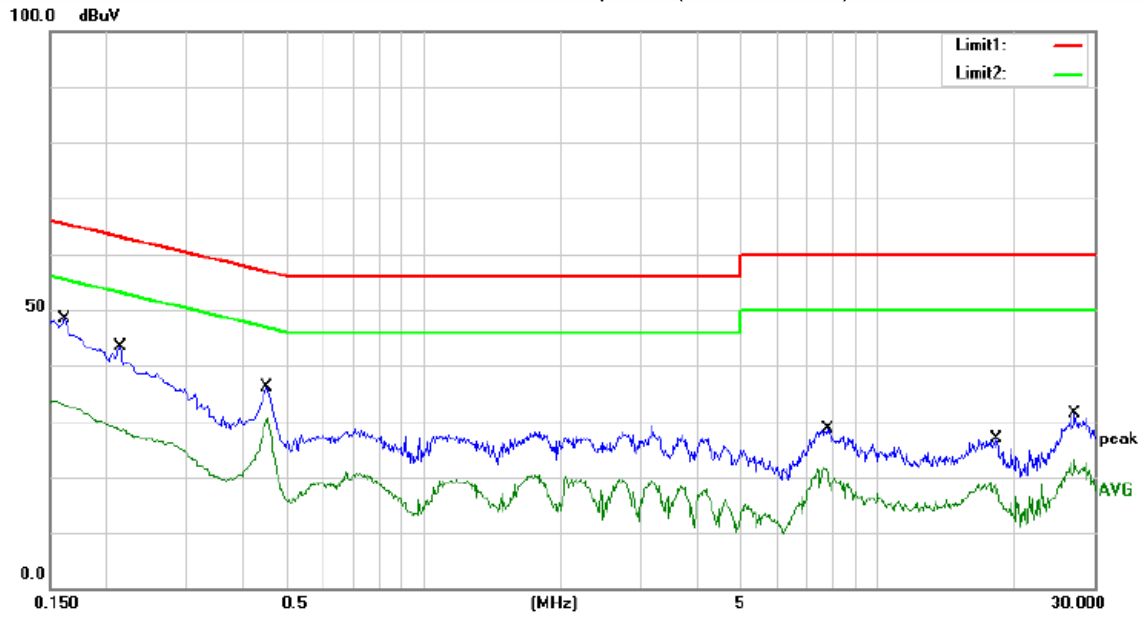

Site site #1 Phase: **L1** Temperature: 24
 Limit: (CE)EN 55032 CLASS B_QP Power: AC 230V/50Hz Humidity: 50 %
 Mode: WIFI CONTROL
 Note:

No.	Mk.	Freq. MHz	Reading Level dBuV	Correct Factor dB	Measurement dBuV	Limit dBuV	Over dB	Detector	Comment
1		0.1620	38.10	10.10	48.20	65.36	-17.16	QP	
2		0.1620	22.80	10.10	32.90	55.36	-22.46	AVG	
3		0.2140	33.20	10.09	43.29	63.05	-19.76	QP	
4		0.2140	18.20	10.09	28.29	53.05	-24.76	AVG	
5		0.4500	25.90	10.07	35.97	56.88	-20.91	QP	
6	*	0.4500	20.30	10.07	30.37	46.88	-16.51	AVG	
7		7.7280	18.20	10.42	28.62	60.00	-31.38	QP	
8		7.7280	9.10	10.42	19.52	50.00	-30.48	AVG	
9		18.2440	16.20	10.59	26.79	60.00	-33.21	QP	
10		18.2440	7.90	10.59	18.49	50.00	-31.51	AVG	
11		27.1600	20.60	10.76	31.36	60.00	-28.64	QP	
12		27.1600	12.40	10.76	23.16	50.00	-26.84	AVG	

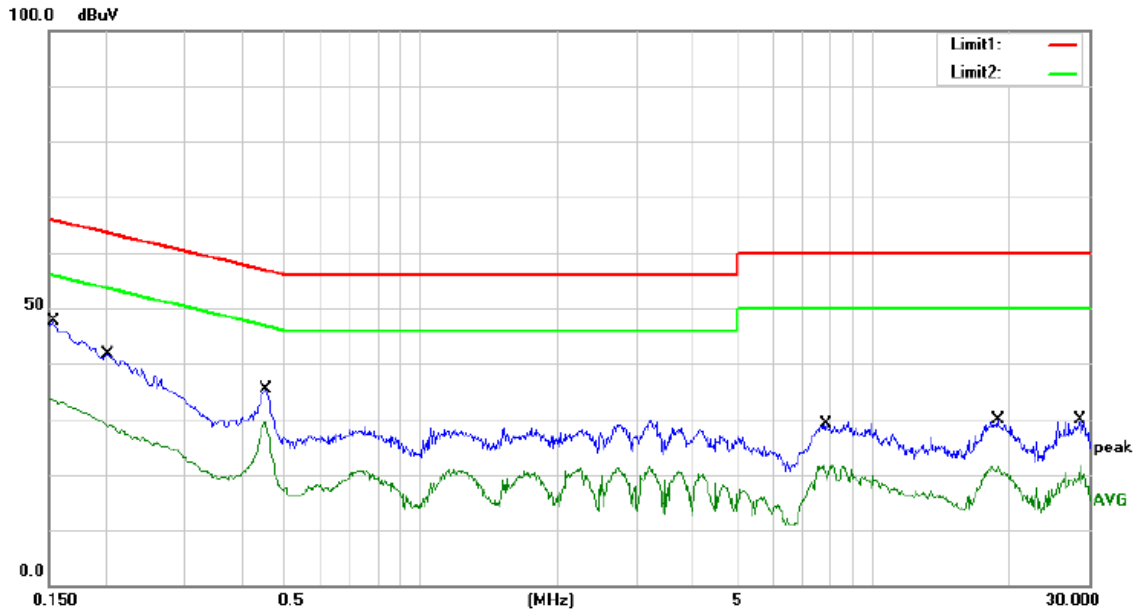

Site site #1 Phase: **N** Temperature: 24
 Limit: (CE)EN 55032 CLASS B_QP Power: AC 230V/50Hz Humidity: 50 %
 Mode: WIFI CONTROL
 Note:

No.	Mk.	Freq. MHz	Reading Level dBuV	Correct Factor dB	Measure- ment dBuV	Limit dBuV	Over dB	Detector	Comment
1		0.1540	37.50	10.08	47.58	65.78	-18.20	QP	
2	*	0.1540	31.60	10.08	41.68	55.78	-14.10	AVG	
3		0.2020	31.60	10.08	41.68	63.53	-21.85	QP	
4		0.2020	18.00	10.08	28.08	53.53	-25.45	AVG	
5		0.4540	25.20	10.11	35.31	56.80	-21.49	QP	
6		0.4540	19.20	10.11	29.31	46.80	-17.49	AVG	
7		7.8700	18.60	10.45	29.05	60.00	-30.95	QP	
8		7.8700	9.60	10.45	20.05	50.00	-29.95	AVG	
9		18.9180	19.10	10.65	29.75	60.00	-30.25	QP	
10		18.9180	10.20	10.65	20.85	50.00	-29.15	AVG	
11		28.6860	19.00	10.41	29.41	60.00	-30.59	QP	
12		28.6860	11.10	10.41	21.51	50.00	-28.49	AVG	

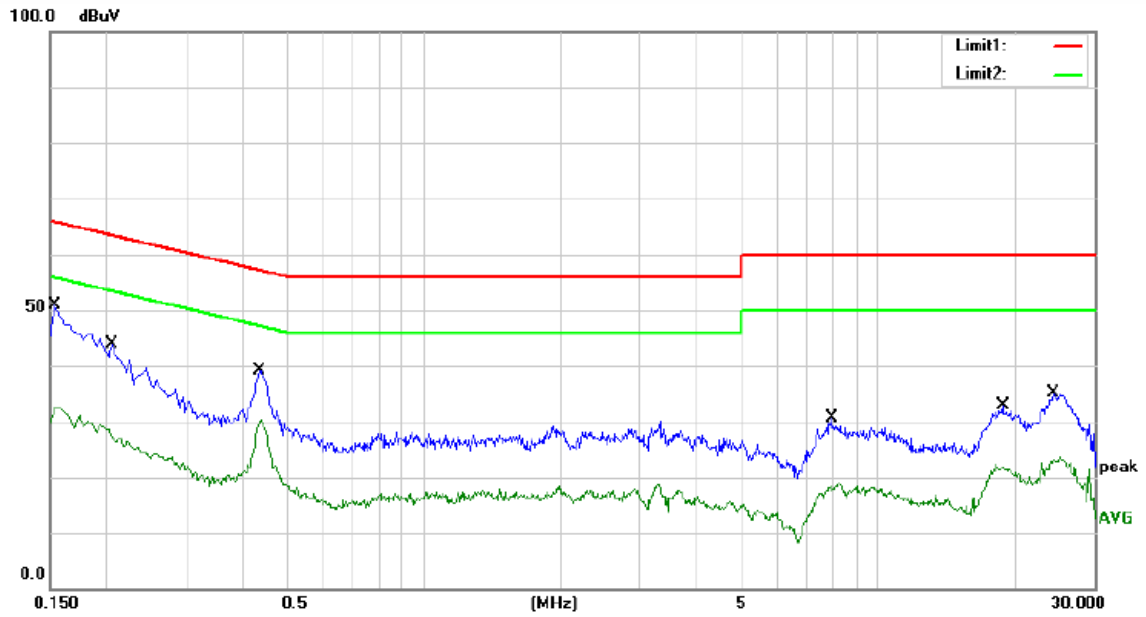

Site site #1 Phase: **N** Temperature: 24
 Limit: (CE)EN 55032 CLASS B_QP Power: AC 120V/60Hz Humidity: 50 %
 Mode: WIFI CONTROL
 Note:

No.	Mk.	Freq. MHz	Reading Level dBuV	Correct Factor dB	Measure- ment dBuV	Limit dBuV	Over dB	Detector	Comment
1	*	0.1540	40.80	10.08	50.88	65.78	-14.90	QP	
2		0.1540	22.40	10.08	32.48	55.78	-23.30	AVG	
3		0.2060	33.70	10.08	43.78	63.37	-19.59	QP	
4		0.2060	17.00	10.08	27.08	53.37	-26.29	AVG	
5		0.4340	29.10	10.10	39.20	57.18	-17.98	QP	
6		0.4340	19.90	10.10	30.00	47.18	-17.18	AVG	
7		7.9220	20.10	10.45	30.55	60.00	-29.45	QP	
8		7.9220	7.20	10.45	17.65	50.00	-32.35	AVG	
9		18.9140	22.10	10.65	32.75	60.00	-27.25	QP	
10		18.9140	10.80	10.65	21.45	50.00	-28.55	AVG	
11		24.2900	24.40	10.54	34.94	60.00	-25.06	QP	
12		24.2900	12.70	10.54	23.24	50.00	-26.76	AVG	

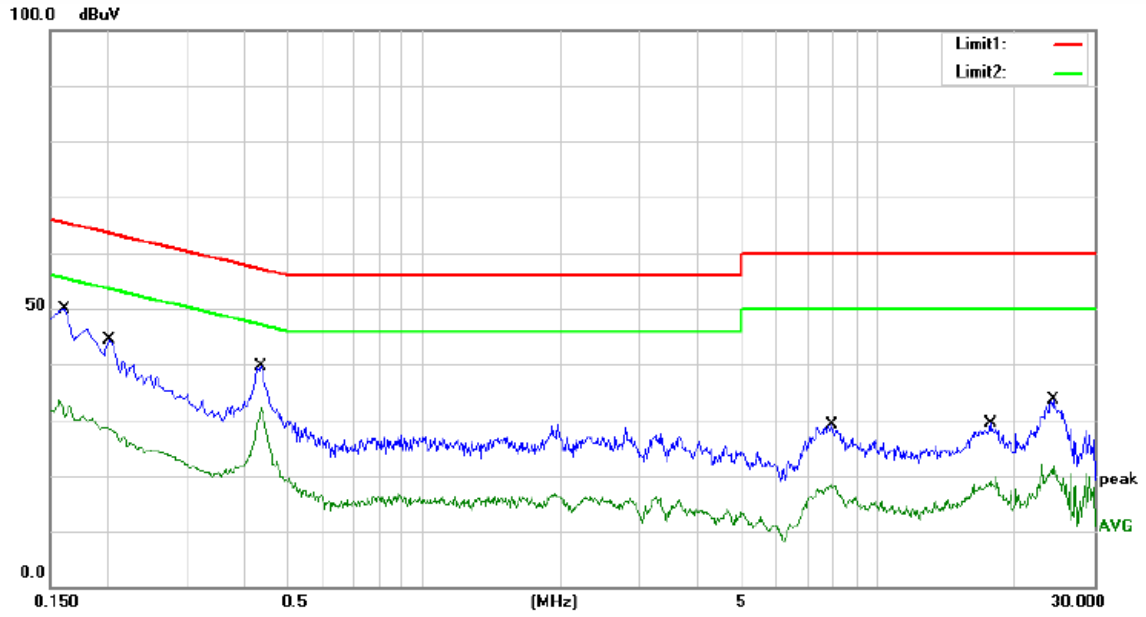

Site site #1 Phase: **L1** Temperature: 24
 Limit: (CE)EN 55032 CLASS B_QP Power: AC 120V/60Hz Humidity: 50 %
 Mode: WIFI CONTROL
 Note:

No.	Mk.	Freq. MHz	Reading Level dBuV	Correct Factor dB	Measure- ment dBuV	Limit dBuV	Over dB	Detector	Comment
1		0.1620	39.80	10.10	49.90	65.36	-15.46	QP	
2		0.1620	20.50	10.10	30.60	55.36	-24.76	AVG	
3		0.2020	34.20	10.09	44.29	63.53	-19.24	QP	
4		0.2020	18.30	10.09	28.39	53.53	-25.14	AVG	
5		0.4380	29.60	10.07	39.67	57.10	-17.43	QP	
6	*	0.4380	22.00	10.07	32.07	47.10	-15.03	AVG	
7		7.9580	18.60	10.43	29.03	60.00	-30.97	QP	
8		7.9580	7.30	10.43	17.73	50.00	-32.27	AVG	
9		17.6940	18.60	10.58	29.18	60.00	-30.82	QP	
10		17.6940	7.40	10.58	17.98	50.00	-32.02	AVG	
11		24.3500	22.90	10.70	33.60	60.00	-26.40	QP	
12		24.3500	10.40	10.70	21.10	50.00	-28.90	AVG	

Project Information(Model DataHub1000 with adapter 2 (BSG025W-1202000A))			
Mode:	RS485+Net Port+TF Card+WIFI	Voltage:	AC 230V/50Hz
Environment:	Temp: 25°C; Humi:60%	Engineer:	Sen Song

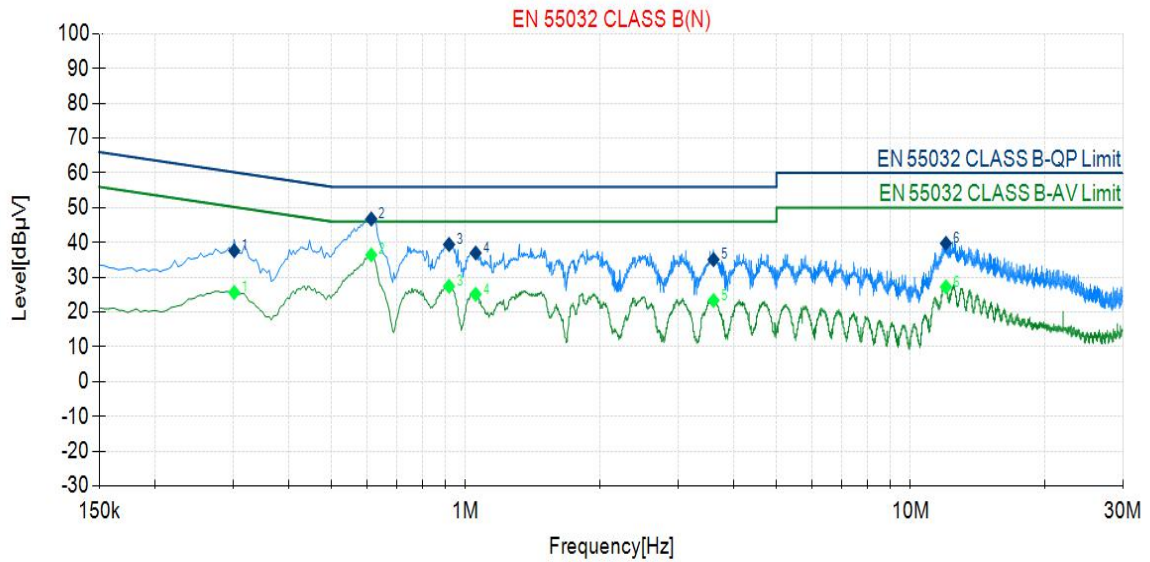

Final Data List											
NO.	Freq. [MHz]	Factor [dB]	QP Reading [dBµV]	QP Value [dBµV]	QP Limit [dBµV]	QP Margin [dB]	AV Reading [dBµV]	AV Value [dBµV]	AV Limit [dBµV]	AV Margin [dB]	Verdict
1	0.302	10.43	27.18	37.61	60.19	22.58	15.17	25.60	50.19	24.59	Pass
2	0.614	10.45	36.3	46.75	56.00	9.25	25.97	36.42	46.00	9.58	Pass
3	0.918	10.50	28.92	39.42	56.00	16.58	16.9	27.40	46.00	18.60	Pass
4	1.054	10.51	26.45	36.96	56.00	19.04	14.59	25.10	46.00	20.90	Pass
5	3.610	10.69	24.38	35.07	56.00	20.93	12.62	23.31	46.00	22.69	Pass
6	12.018	10.81	28.93	39.74	60.00	20.26	16.41	27.22	50.00	22.78	Pass

Project Information(Model DataHub1000 with adapter 2 (BSG025W-1202000A))			
Mode:	RS485+Net Port+TF Card+WIFI	Voltage:	AC 230V/50Hz
Environment:	Temp: 25°C; Humi:60%	Engineer:	Sen Song

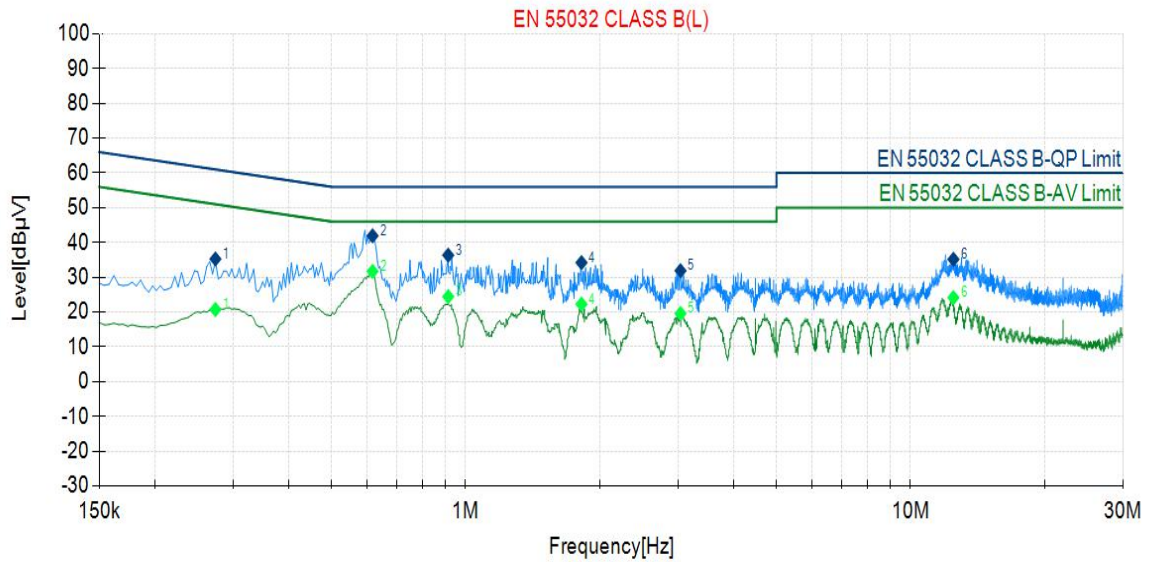

Final Data List											
NO.	Freq. [MHz]	Factor [dB]	QP Reading [dBµV]	QP Value [dBµV]	QP Limit [dBµV]	QP Margin [dB]	AV Reading [dBµV]	AV Value [dBµV]	AV Limit [dBµV]	AV Margin [dB]	Verdict
1	0.274	10.48	24.78	35.26	61.00	25.74	10.22	20.70	51.00	30.30	Pass
2	0.618	10.36	31.56	41.92	56.00	14.08	21.32	31.68	46.00	14.32	Pass
3	0.914	10.36	25.99	36.35	56.00	19.65	14.07	24.43	46.00	21.57	Pass
4	1.822	10.40	23.80	34.20	56.00	21.80	11.87	22.27	46.00	23.73	Pass
5	3.042	10.43	21.45	31.88	56.00	24.12	9.13	19.56	46.00	26.44	Pass
6	12.490	10.67	24.48	35.15	60.00	24.85	13.46	24.13	50.00	25.87	Pass

Project Information(Model DataHub1000 with adapter 2 (BSG025W-1202000A))			
Mode:	RS485+Net Port+TF Card+WIFI	Voltage:	AC 120V/60Hz
Environment:	Temp: 25°C; Humi:60%	Engineer:	Sen Song

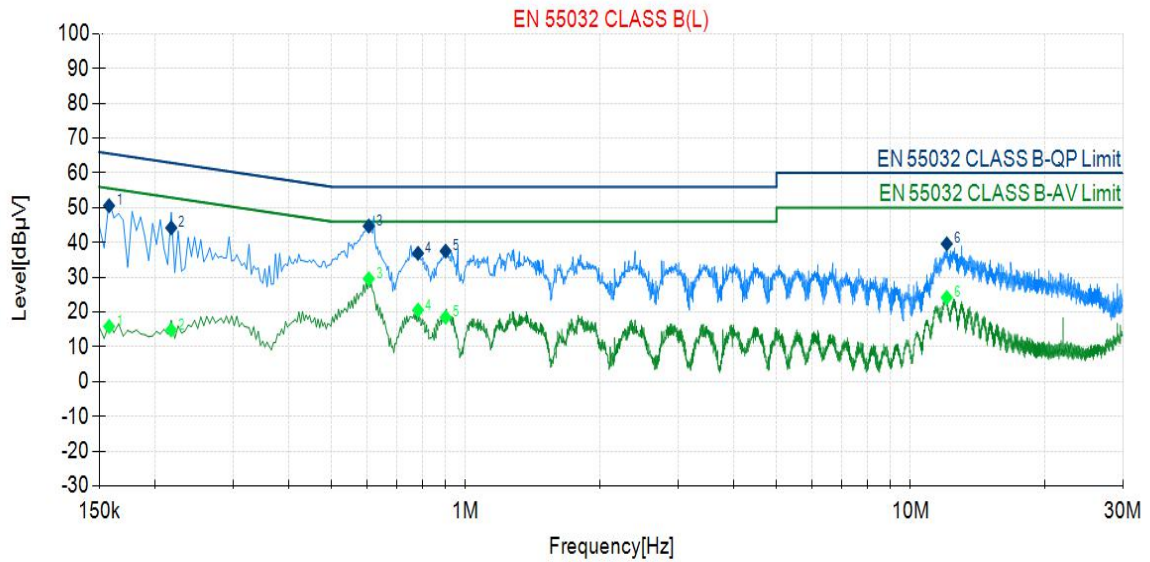

Final Data List											
NO.	Freq. [MHz]	Factor [dB]	QP Reading [dBµV]	QP Value [dBµV]	QP Limit [dBµV]	QP Margin [dB]	AV Reading [dBµV]	AV Value [dBµV]	AV Limit [dBµV]	AV Margin [dB]	Verdict
1	0.158	10.51	40.05	50.56	65.57	15.01	5.33	15.84	55.57	39.73	Pass
2	0.218	10.49	33.71	44.20	62.89	18.69	4.32	14.81	52.89	38.08	Pass
3	0.606	10.36	34.34	44.70	56.00	11.30	19.19	29.55	46.00	16.45	Pass
4	0.782	10.35	26.53	36.88	56.00	19.12	10.19	20.54	46.00	25.46	Pass
5	0.902	10.36	27.15	37.51	56.00	18.49	8.11	18.47	46.00	27.53	Pass
6	12.070	10.67	28.93	39.60	60.00	20.40	13.5	24.17	50.00	25.83	Pass

Project Information(Model DataHub1000 with adapter 2 (BSG025W-1202000A))			
Mode:	RS485+Net Port+TF Card+WIFI	Voltage:	AC 120V/60Hz
Environment:	Temp: 25°C; Humi:60%	Engineer:	Sen Song

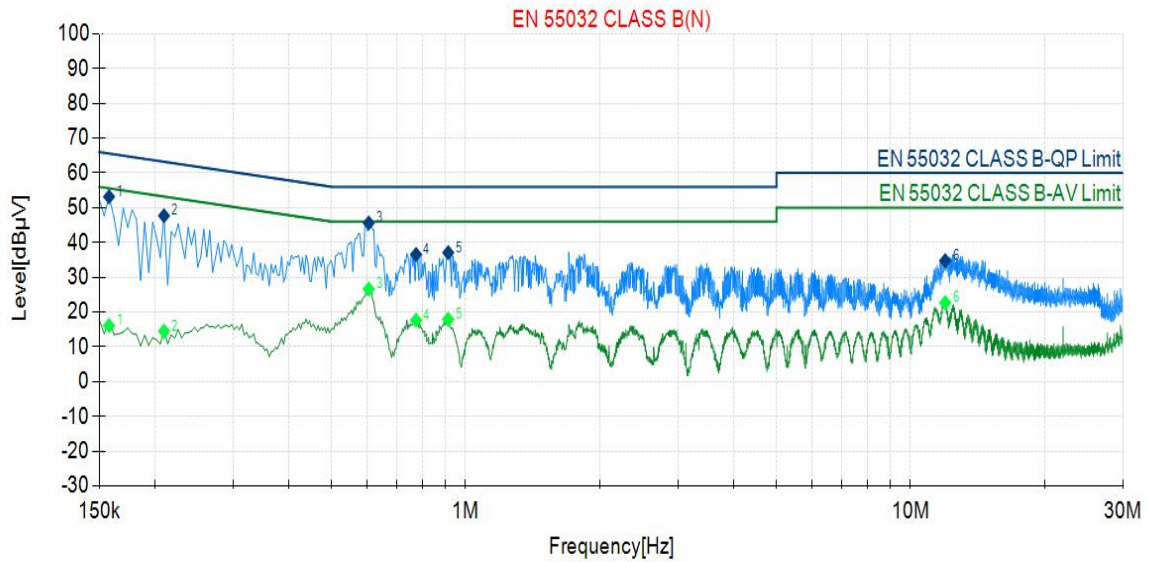

Final Data List											
NO.	Freq. [MHz]	Factor [dB]	QP Reading [dBµV]	QP Value [dBµV]	QP Limit [dBµV]	QP Margin [dB]	AV Reading [dBµV]	AV Value [dBµV]	AV Limit [dBµV]	AV Margin [dB]	Verdict
1	0.158	10.49	42.65	53.14	65.57	12.43	5.6	16.09	55.57	39.48	Pass
2	0.210	10.46	37.22	47.68	63.21	15.53	4	14.46	53.21	38.75	Pass
3	0.606	10.45	35.16	45.61	56.00	10.39	16.16	26.61	46.00	19.39	Pass
4	0.774	10.49	26.07	36.56	56.00	19.44	7.14	17.63	46.00	28.37	Pass
5	0.914	10.50	26.57	37.07	56.00	18.93	7.39	17.89	46.00	28.11	Pass
6	11.974	10.81	23.95	34.76	60.00	25.24	11.87	22.68	50.00	27.32	Pass

5. ASYMMETRIC MODE CONDUCTED EMISSIONS AT WIRED NETWORK PORTS

5.1. Block Diagram of Test Setup

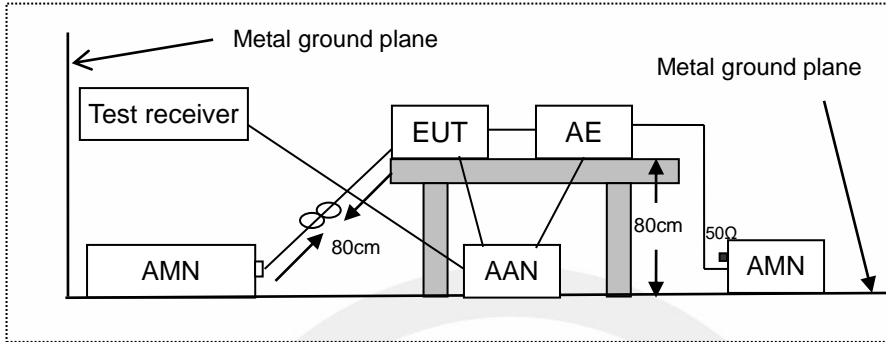

AMN: Artificial mains network
 AE: Associated equipment
 EUT: Equipment under test
 AAN: Asymmetric artificial network

5.2. Limits

EN 55032, Class B, Table A.12

Frequency range (MHz)	Coupling device (see Table A.8)	Detector type / bandwidth	Class B voltage limits dB(μ V)	Class B current limits dB(μ A)
0.15 to 0.5	AAN	Quasi Peak / 9 kHz	84 to 74	N/A
0.5 to 30			74	
0.15 to 0.5	AAN	Average / 9 kHz	74 to 64	
0.5 to 30			64	
0.15 to 0.5	CVP and current probe	Quasi Peak / 9 kHz	84 to 74	40 to 30
0.5 to 30			74	30
0.15 to 0.5	CVP and current probe	Average / 9 kHz	74 to 64	30 to 20
0.5 to 30			64	20
0.15 to 0.5	Current Probe	Quasi Peak / 9 kHz	N/A	40 to 30
0.5 to 30				30
0.15 to 0.5	Current Probe	Average / 9 kHz		30 to 20
0.5 to 30				20

5.3. Test Procedure

The EUT is put on the plane 0.8m high above the ground by insulating support and connected to the AC mains through artificial mains network(AMN) or connected to the wired network port through an asymmetric artificial network(AAN). AMN provided a 50ohm coupling impedance for the tested equipment AC mains port, AAN provided a common mode (asymmetric mode) impedance of 150 Ω to the wired network port under test. Both sides of AC line and the wired network line are investigated to

find out the maximum conducted emission according to the EN 55032 regulations during conducted emission measurement.

The bandwidth of the receiver is set at 9 kHz in 150 kHz~30 MHz. The frequency range from 150 kHz to 30 MHz is investigated.

Test results were obtained from the following equation:
Measurement (dB μ V) = Correct Factor (dB) + Reading (dB μ V)
Over (dB) = Measurement (dB μ V) - Limit (dB μ V)

5.4. Measuring Results

Pass.

Please refer to the following pages.



Model DataHub1000 with adapter 1 (ABT020120A)

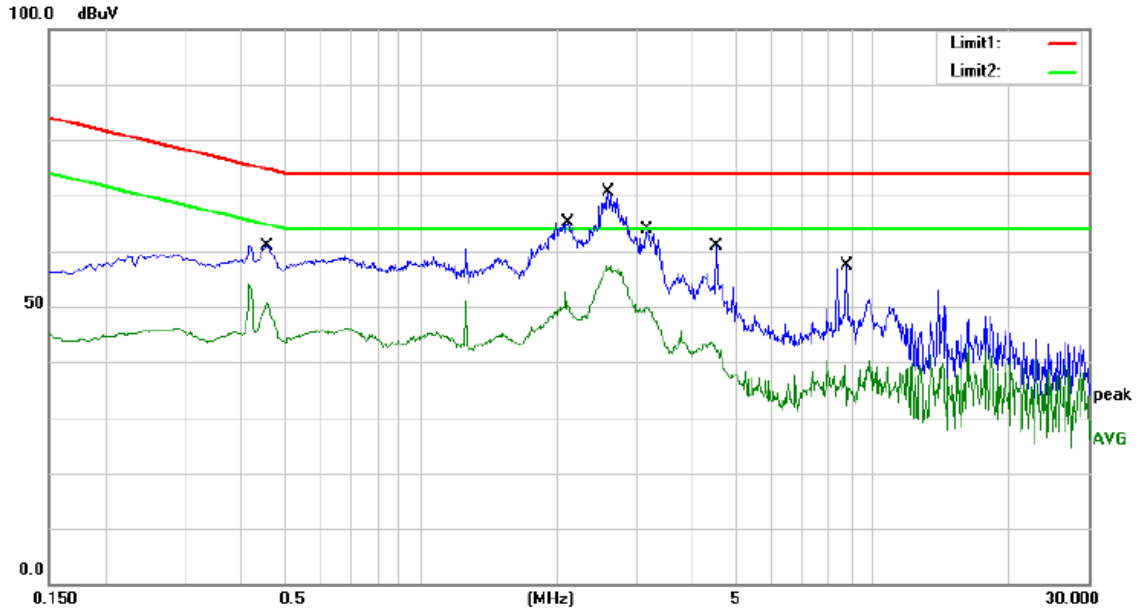

Site site #1 Phase: Temperature: 24
 Limit: (CE)EN 55032 Class B TELECOM_QP Power: AC 230V/50Hz Humidity: 50 %
 Mode: WIFI CONTROL
 Note:

No.	Mk.	Freq. MHz	Reading Level dBuV	Correct Factor dB	Measure- ment dBuV	Limit dBuV	Over dB	Detector	Comment
1		0.4580	35.90	19.84	55.74	74.73	-18.99	QP	
2		0.4580	30.30	19.84	50.14	64.73	-14.59	AVG	
3		2.1140	39.80	19.67	59.47	74.00	-14.53	QP	
4		2.1140	30.10	19.67	49.77	64.00	-14.23	AVG	
5		2.5980	45.20	19.71	64.91	74.00	-9.09	QP	
6	*	2.5980	36.90	19.71	56.61	64.00	-7.39	AVG	
7		3.1620	37.40	19.75	57.15	74.00	-16.85	QP	
8		3.1620	29.80	19.75	49.55	64.00	-14.45	AVG	
9		4.5140	28.40	19.85	48.25	74.00	-25.75	QP	
10		4.5140	21.90	19.85	41.75	64.00	-22.25	AVG	
11		8.7460	24.50	19.90	44.40	74.00	-29.60	QP	
12		8.7460	19.40	19.90	39.30	64.00	-24.70	AVG	

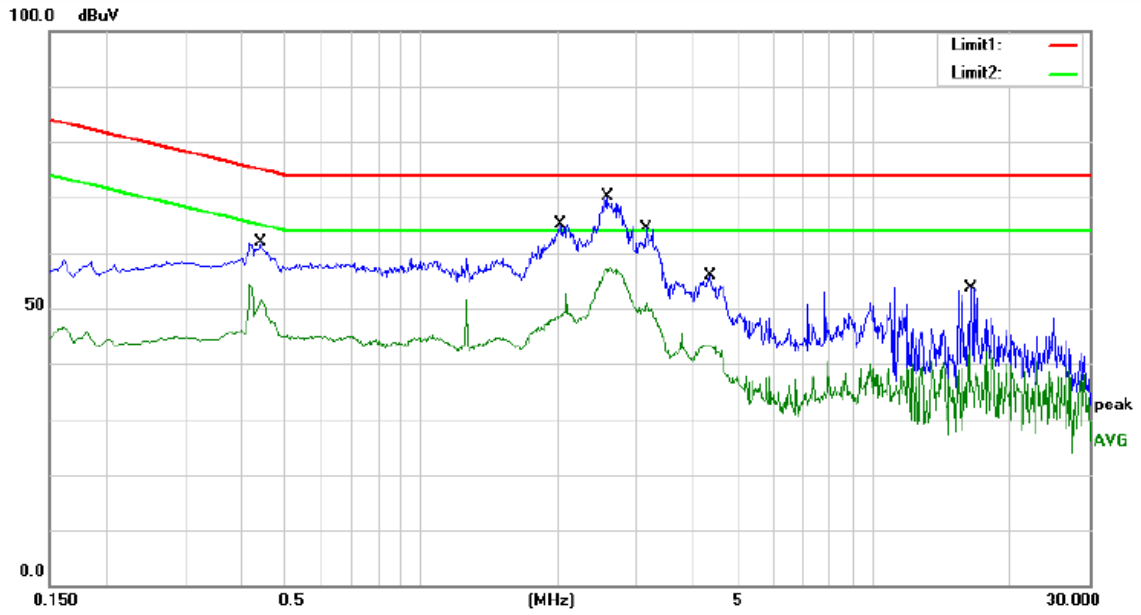

Site site #1 Phase: Temperature: 24
 Limit: (CE)EN 55032 Class B TELECOM_QP Power: AC 120V/60Hz Humidity: 50 %
 Mode: WIFI CONTROL
 Note:

No.	Mk.	Freq. MHz	Reading Level dBuV	Correct Factor dB	Measure- ment dBuV	Limit dBuV	Over dB	Detector	Comment
1		0.4420	36.50	19.84	56.34	75.02	-18.68	QP	
2		0.4420	31.70	19.84	51.54	65.02	-13.48	AVG	
3		2.0260	38.40	19.66	58.06	74.00	-15.94	QP	
4		2.0260	28.80	19.66	48.46	64.00	-15.54	AVG	
5		2.5780	45.50	19.70	65.20	74.00	-8.80	QP	
6	*	2.5780	36.90	19.70	56.60	64.00	-7.40	AVG	
7		3.1500	37.60	19.75	57.35	74.00	-16.65	QP	
8		3.1500	30.20	19.75	49.95	64.00	-14.05	AVG	
9		4.3460	29.70	19.84	49.54	74.00	-24.46	QP	
10		4.3460	23.10	19.84	42.94	64.00	-21.06	AVG	
11		16.4740	21.40	19.91	41.31	74.00	-32.69	QP	
12		16.4740	17.30	19.91	37.21	64.00	-26.79	AVG	

Project Information(Model DataHub1000 with adapter 2 (BSG025W-1202000A))			
Mode:	RS485+Net Port+TF Card+WIFI	Voltage:	AC 120V/60Hz
Environment:	Temp: 25°C; Humi:60%	Engineer:	Conan Wen

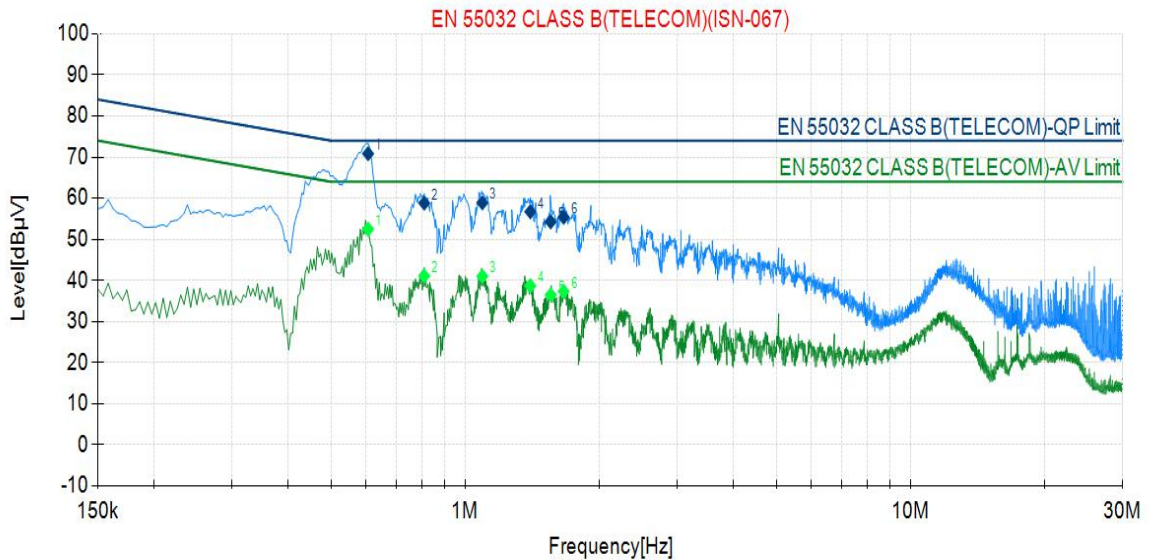

Final Data List											
NO.	Freq. [MHz]	Factor [dB]	QP Reading [dBµV]	QP Value [dBµV]	QP Limit [dBµV]	QP Margin [dB]	AV Reading [dBµV]	AV Value [dBµV]	AV Limit [dBµV]	AV Margin [dB]	Verdict
1	0.606	10.36	60.46	70.82	74.00	3.18	42.12	52.48	64.00	11.52	Pass
2	0.810	10.42	48.39	58.81	74.00	15.19	30.65	41.07	64.00	22.93	Pass
3	1.094	10.48	48.41	58.89	74.00	15.11	30.53	41.01	64.00	22.99	Pass
4	1.402	10.50	46.21	56.71	74.00	17.29	28.18	38.68	64.00	25.32	Pass
5	1.558	10.51	43.74	54.25	74.00	19.75	25.96	36.47	64.00	27.53	Pass
6	1.666	10.52	44.87	55.39	74.00	18.61	26.82	37.34	64.00	26.66	Pass

Project Information(Model DataHub1000 with adapter 2 (BSG025W-1202000A))			
Mode:	RS485+Net Port+TF Card+WIFI	Voltage:	AC 230V/50Hz
Environment:	Temp: 25°C; Humi:60%	Engineer:	Conan Wen

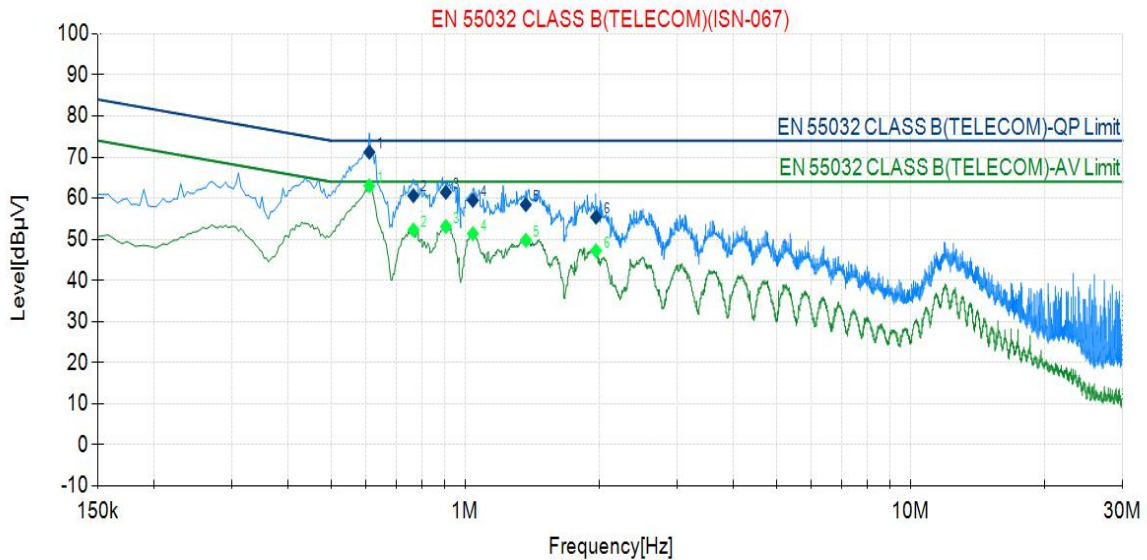

Final Data List											
NO.	Freq. [MHz]	Factor [dB]	QP Reading [dBµV]	QP Value [dBµV]	QP Limit [dBµV]	QP Margin [dB]	AV Reading [dBµV]	AV Value [dBµV]	AV Limit [dBµV]	AV Margin [dB]	Verdict
1	0.610	10.36	60.82	71.18	74.00	2.82	52.63	62.99	64.00	1.01	Pass
2	0.766	10.41	50.22	60.63	74.00	13.37	41.85	52.26	64.00	11.74	Pass
3	0.906	10.45	50.98	61.43	74.00	12.57	42.68	53.13	64.00	10.87	Pass
4	1.042	10.48	49.00	59.48	74.00	14.52	40.88	51.36	64.00	12.64	Pass
5	1.370	10.49	47.94	58.43	74.00	15.57	39.27	49.76	64.00	14.24	Pass
6	1.970	10.53	44.89	55.42	74.00	18.58	36.67	47.20	64.00	16.80	Pass

6. RADIATED EMISSION MEASUREMENT (UP TO 1GHz)

6.1. Block Diagram of Test Setup

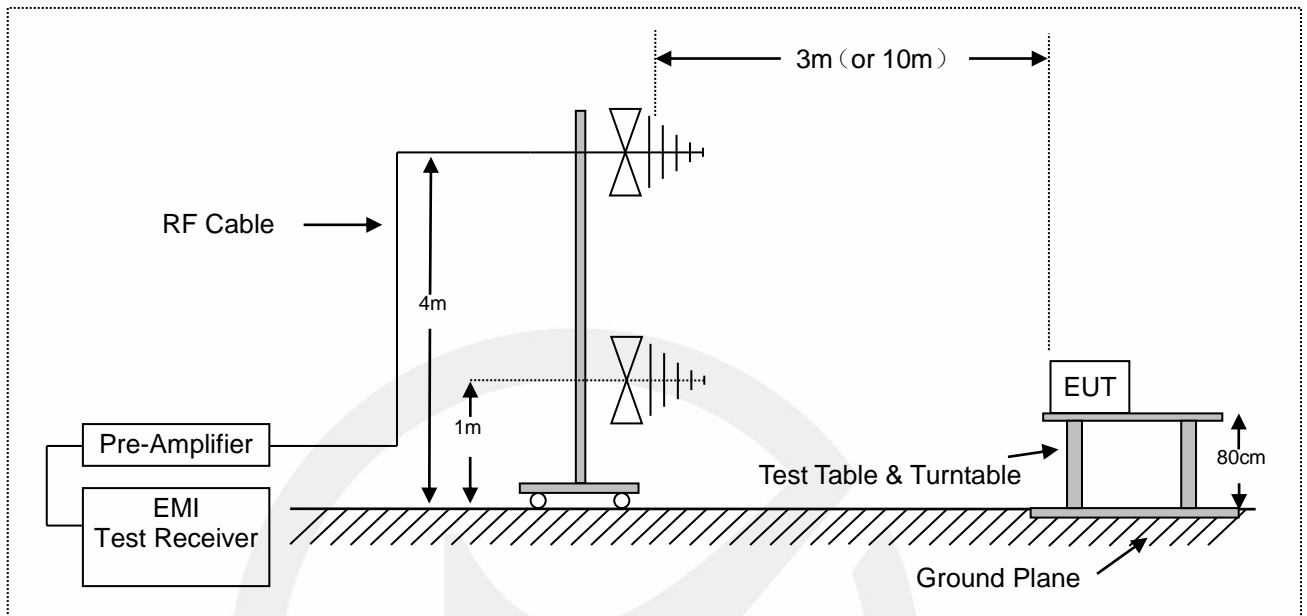

6.2. Radiated Limit

EN 55032, Class B, Table A.4

Frequency range MHz	Measurement			Class B limits dB(μ V/m)
	Facility	Distance (m)	Detector type / bandwidth	
30 to 230	OATS/SAC	10	Quasi Peak / 120 kHz	30
230 to 1 000				37
30 to 230	OATS/SAC	3		40
230 to 1 000				47

6.3. Test Procedure

The EUT was placed on a non-conductive table whose total height equaled 80cm. All units of equipment forming the system under test (includes the EUT as well as connected peripherals and associated equipment or devices) shall be arranged such that a nominal 0.1 m separation is achieved between the neighboring units. Where the mains cable supplied by the manufacturer is longer than 1 m, the excess should be folded at the centre into a bundle no longer than 0.4 m, so that its length is shortened to 1 m.

The EUT was set 3 meters (or 10 meters) away from the receiving antenna that was mounted on a non-conductive mast. The antenna can move up and down between 1 to 4 meters to find out the maximum emission level.

The turntable can rotate 360 degree to determine the position of the maximum emission level.

The initial testing identified the frequency that has the highest disturbance relative to the limit while operating the EUT in typical modes of operation and cable positions in a test setup representative of typical system configuration.

The identification of the frequency of highest emission with respect to the limit was found by investigating emissions at a number of significant frequencies. The probable frequency of maximum emission had been found and that the associated cable and EUT configuration and mode of operation had been identified.

The bandwidth of the Receiver is set at 120 kHz.

Test results were obtained from the following equation:
Measurement (dB μ V) =Correct Factor (dB) + Reading (dB μ V)
Over (dB) = Measurement (dB μ V) - Limit (dB μ V)

6.4. Measuring Results

Pass.

Please refer to the following pages.

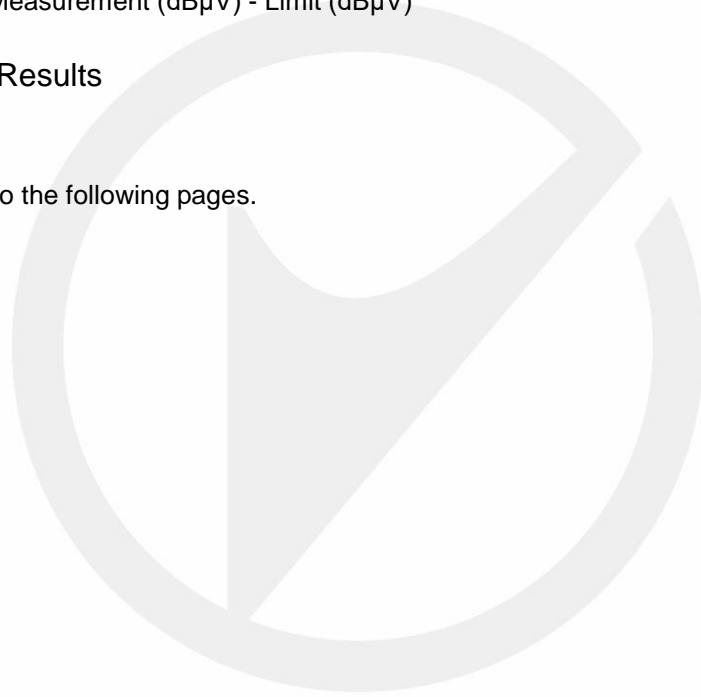

Model DataHub1000 with adapter 1 (ABT020120A)

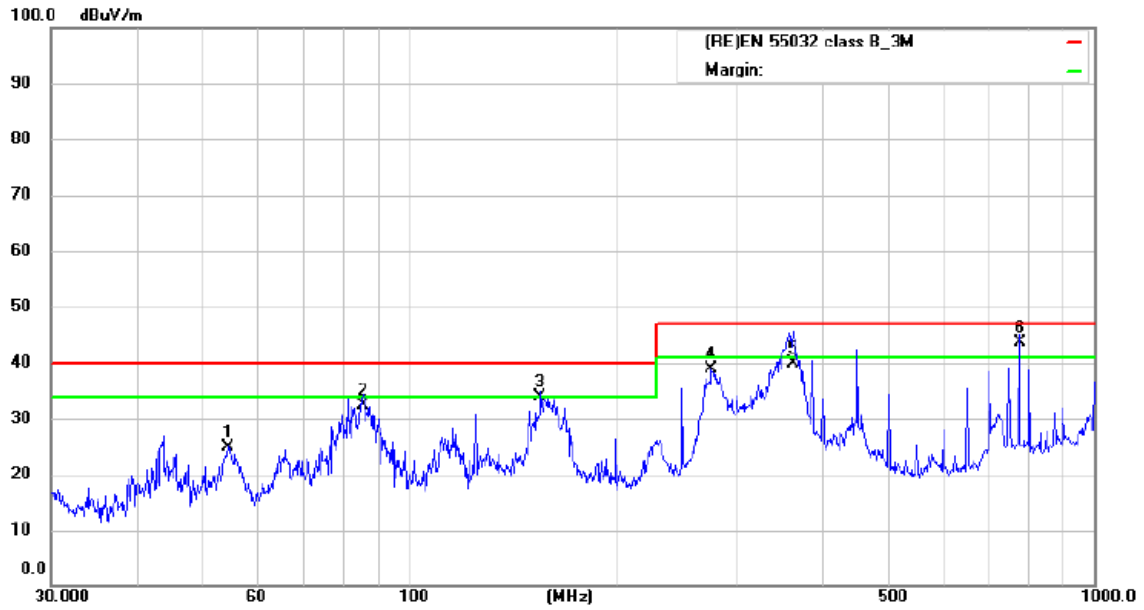

Site Radiated Emission 3m #1
 Limit: (RE)EN 55032 class B_3M
 Mode: WIFI CONTROL
 Note:

Polarization: **Horizontal**
 Power: AC 230V/50Hz

Temperature: 24
 Humidity: 55 %

No.	Mk.	Freq.	Reading Level	Correct Factor	Measurement	Limit	Over	Antenna Height	Table Degree	
		MHz	dBuV	dB	dBuV/m	dBuV/m	dB	cm	degree	Comment
1		54.4515	46.12	-21.12	25.00	40.00	-15.00			QP
2		85.5974	58.90	-26.60	32.30	40.00	-7.70			QP
3		155.3642	60.81	-27.01	33.80	40.00	-6.20			QP
4		276.1234	59.41	-20.61	38.80	47.00	-8.20			QP
5		362.9844	59.24	-19.24	40.00	47.00	-7.00			QP
6	*	776.8778	53.26	-9.66	43.60	47.00	-3.40			QP

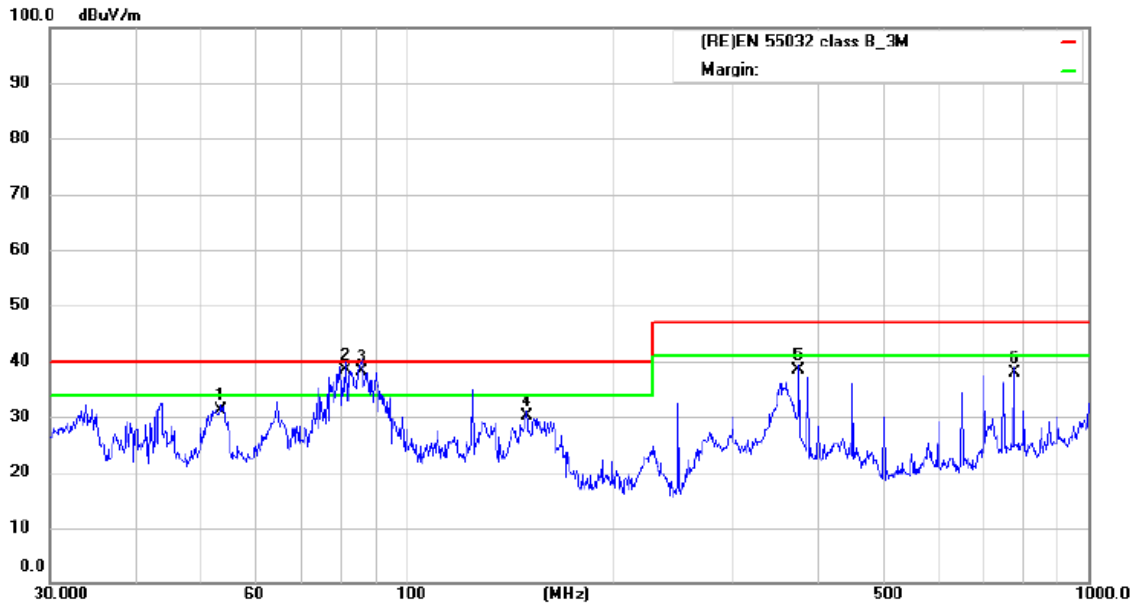

Site Radiated Emission 3m #1
 Limit: (RE)EN 55032 class B_3M
 Mode:WIFI CONTROL
 Note:

Polarization: *Vertical*
 Power: AC 230V/50Hz

Temperature: 24
 Humidity: 55 %

No.	Mk.	Freq. MHz	Reading Level dBuV	Correct Factor dB	Measure- ment dBuV/m	Limit dBuV/m	Over dB	Detector	Antenna Height cm	Table Degree	Comment
1		53.5052	52.21	-21.01	31.20	40.00	-8.80	QP			
2	*	81.2116	65.88	-27.48	38.40	40.00	-1.60	QP			
3	!	85.8984	64.67	-26.47	38.20	40.00	-1.80	QP			
4		150.0107	56.33	-26.23	30.10	40.00	-9.90	QP			
5		375.9384	56.71	-18.41	38.30	47.00	-8.70	QP			
6		776.8777	47.66	-9.66	38.00	47.00	-9.00	QP			

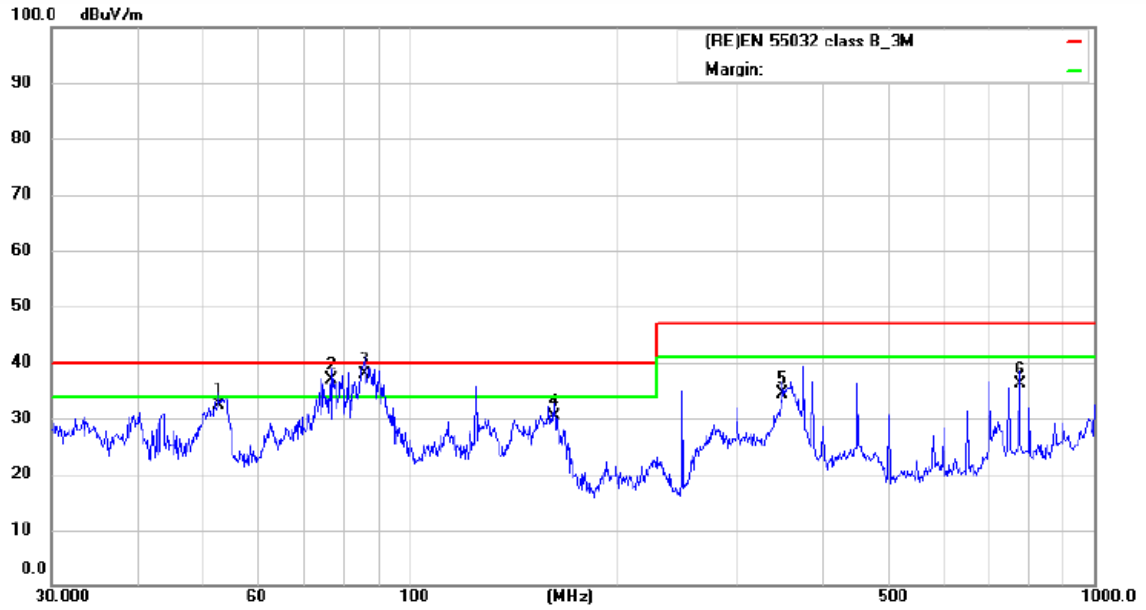

Site Radiated Emission 3m #1

Polarization: *Vertical*

Temperature: 24

Limit: (RE)EN 55032 class B_3M

Power: AC 120V/60Hz

Humidity: 55 %

Mode: WIFI CONTROL

Note:

No.	Mk.	Freq. MHz	Reading Level dBuV	Correct Factor dB	Measure- ment dBuV/m	Limit dBuV/m	Over dB	Detector	Antenna Height cm	Table Degree degree	Comment
1		52.5752	53.52	-21.02	32.50	40.00	-7.50	QP			
2	!	77.0503	64.20	-27.40	36.80	40.00	-3.20	QP			
3	*	85.8984	64.37	-26.47	37.90	40.00	-2.10	QP			
4		162.6105	57.28	-26.98	30.30	40.00	-9.70	QP			
5		350.4766	54.07	-19.57	34.50	47.00	-12.50	QP			
6		776.8777	45.86	-9.66	36.20	47.00	-10.80	QP			

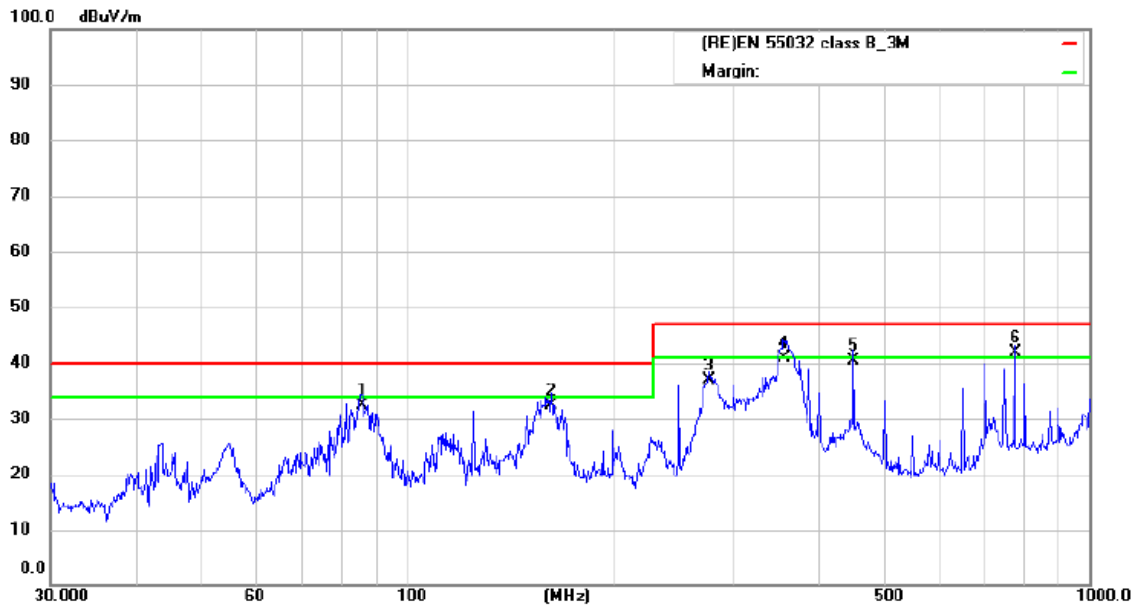

Site Radiated Emission 3m #1

Polarization: **Horizontal**

Temperature: 24

Limit: (RE)EN 55032 class B_3M

Power: AC 120V/60Hz

Humidity: 55 %

Mode:WIFI CONTROL

Note:

No.	Mk.	Freq. MHz	Reading Level dBuV	Correct Factor dB	Measure- ment dBuV/m	Limit dBuV/m	Over dB	Detector	Antenna Height cm	Table Degree degree	Comment
1		85.8983	58.97	-26.47	32.50	40.00	-7.50	QP			
2		162.6105	59.38	-26.98	32.40	40.00	-7.60	QP			
3		277.0935	57.43	-20.63	36.80	47.00	-10.20	QP			
4		355.4273	60.50	-19.50	41.00	47.00	-6.00	QP			
5		451.1349	58.63	-18.33	40.30	47.00	-6.70	QP			
6	*	776.8778	51.56	-9.66	41.90	47.00	-5.10	QP			

Project Information(Model DataHub1000 with adapter 2 (BSG025W-1202000A))			
Mode:	RS485+Net Port+TF Card+WIFI	Voltage:	AC 120V/60Hz
Environment:	Temp: 25°C; Humi:60%	Engineer:	Alarak Wu

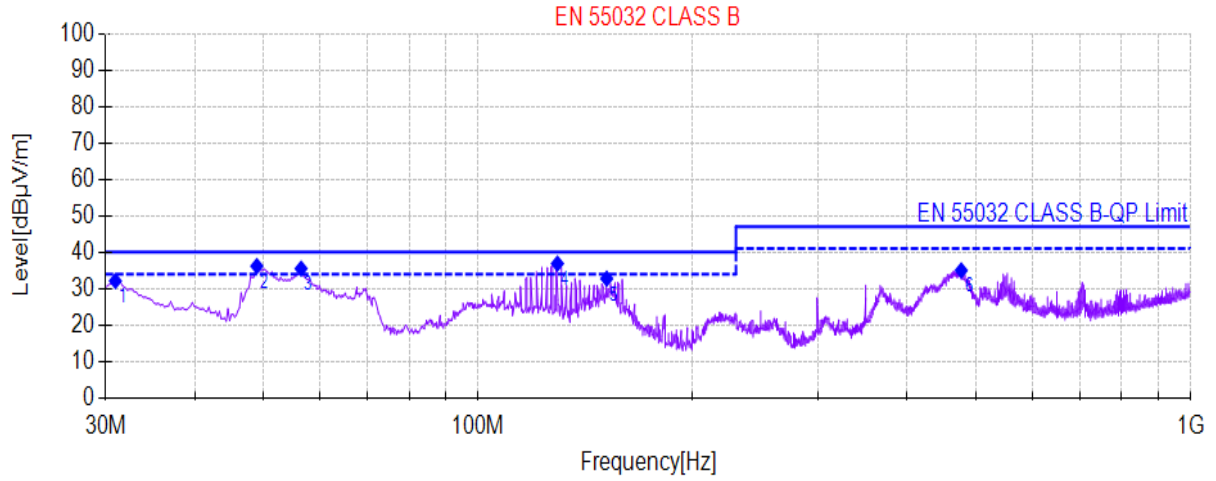

Final Data List										
NO.	Freq. [MHz]	QP Reading [dBµV/m]	Factor [dB]	QP Value [dBµV/m]	QP Limit [dBµV/m]	QP Margin [dB]	Height [cm]	Angle [°]	Polarity	Verdict
1	30.970	56.53	-24.43	32.10	40.00	7.90	100	298	Vertical	Pass
2	48.915	58.72	-22.52	36.20	40.00	3.80	100	33	Vertical	Pass
3	56.433	57.82	-22.33	35.49	40.00	4.51	100	127	Vertical	Pass
4	129.183	61.68	-24.81	36.87	40.00	3.13	100	84	Vertical	Pass
5	151.493	58.46	-25.72	32.74	40.00	7.26	100	202	Vertical	Pass
6	476.443	51.73	-16.73	35.00	47.00	12.00	100	103	Vertical	Pass

Project Information(Model DataHub1000 with adapter 2 (BSG025W-1202000A))			
Mode:	RS485+Net Port+TF Card+WIFI	Voltage:	AC 120V/60Hz
Environment:	Temp: 25°C; Humi:60%	Engineer:	Alarak Wu

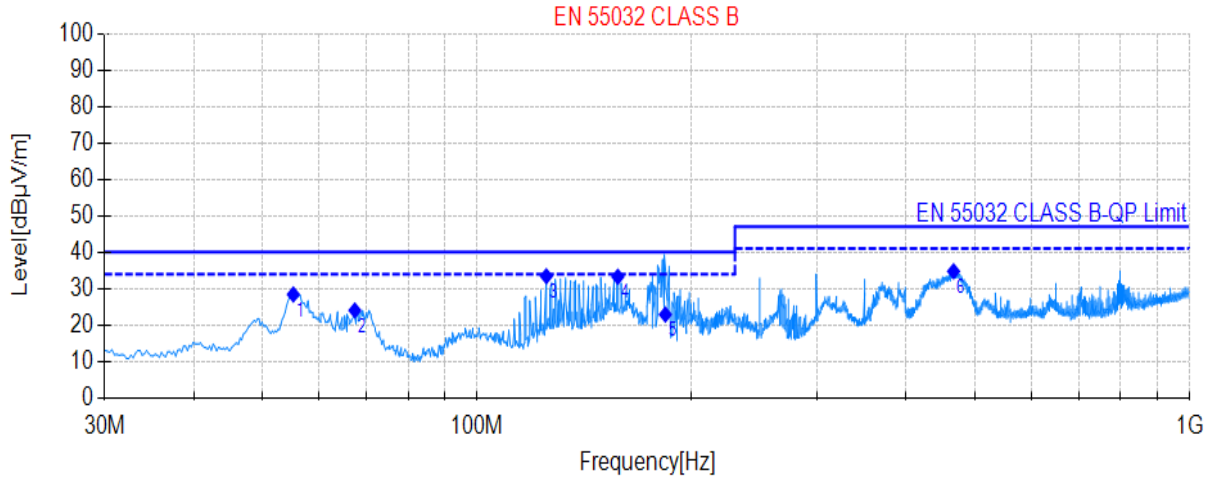

Final Data List										
NO.	Freq. [MHz]	QP Reading [dBµV/m]	Factor [dB]	QP Value [dBµV/m]	QP Limit [dBµV/m]	QP Margin [dB]	Height [cm]	Angle [°]	Polarity	Verdict
1	55.220	50.78	-22.39	28.39	40.00	11.61	100	73	Horizontal	Pass
2	67.345	47.56	-23.54	24.02	40.00	15.98	100	4	Horizontal	Pass
3	125.060	57.86	-24.46	33.40	40.00	6.60	100	248	Horizontal	Pass
4	157.555	58.40	-25.14	33.26	40.00	6.74	100	275	Horizontal	Pass
5	183.707	46.98	-24.11	22.87	40.00	17.13	100	129	Horizontal	Pass
6	466.258	51.74	-16.99	34.75	47.00	12.25	100	248	Horizontal	Pass

Project Information(Model DataHub1000 with adapter 2 (BSG025W-1202000A))			
Mode:	RS485+Net Port+TF Card+WIFI	Voltage:	AC 230V/50Hz
Environment:	Temp: 25°C; Humi:60%	Engineer:	Alarak Wu

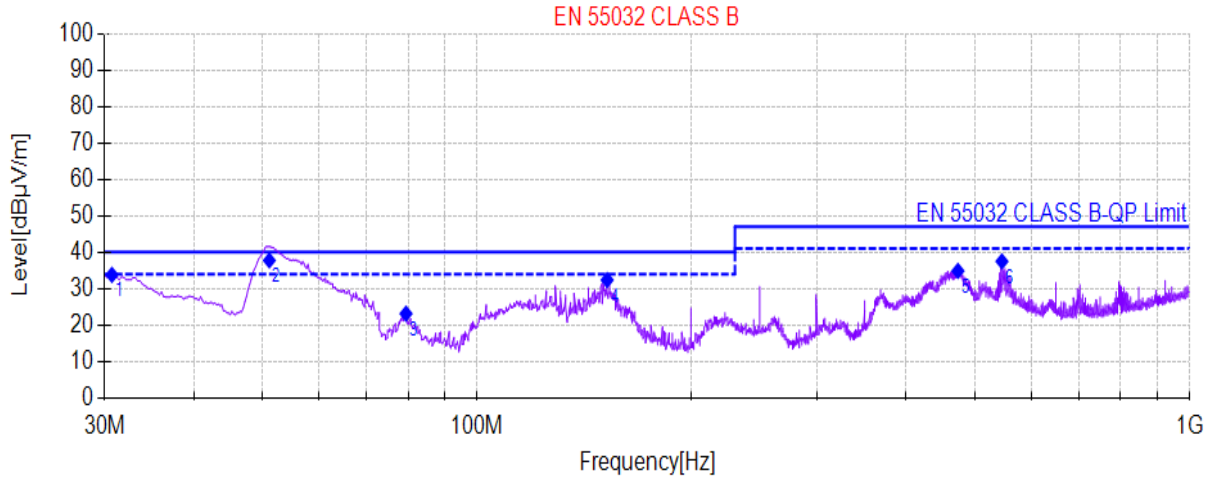

Final Data List										
NO.	Freq. [MHz]	QP Reading [dBµV/m]	Factor [dB]	QP Value [dBµV/m]	QP Limit [dBµV/m]	QP Margin [dB]	Height [cm]	Angle [°]	Polarity	Verdict
1	30.728	58.23	-24.46	33.77	40.00	6.23	100	211	Vertical	Pass
2	51.093	60.02	-22.27	37.75	40.00	2.25	100	321	Vertical	Pass
3	79.470	48.26	-25.13	23.13	40.00	16.87	100	92	Vertical	Pass
4	152.220	58.00	-25.65	32.35	40.00	7.65	100	270	Vertical	Pass
5	472.805	51.68	-16.82	34.86	47.00	12.14	100	4	Vertical	Pass
6	545.070	52.06	-14.58	37.48	47.00	9.52	100	265	Vertical	Pass

Project Information(Model DataHub1000 with adapter 2 (BSG025W-1202000A))			
Mode:	RS485+Net Port+TF Card+WIFI	Voltage:	AC 230V/50Hz
Environment:	Temp: 25°C; Humi:60%	Engineer:	Alarak Wu

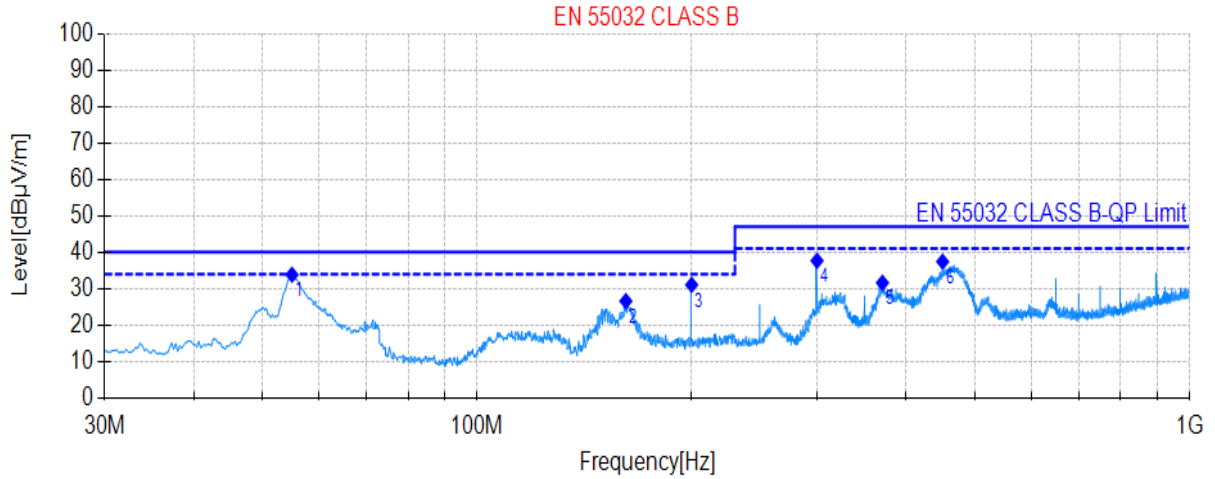

Final Data List										
NO.	Freq. [MHz]	QP Reading [dBµV/m]	Factor [dB]	QP Value [dBµV/m]	QP Limit [dBµV/m]	QP Margin [dB]	Height [cm]	Angle [°]	Polarity	Verdict
1	54.978	56.22	-22.40	33.82	40.00	6.18	100	53	Horizontal	Pass
2	161.678	51.45	-24.87	26.58	40.00	13.42	100	330	Horizontal	Pass
3	199.991	54.26	-23.22	31.04	40.00	8.96	100	274	Horizontal	Pass
4	299.903	57.81	-20.16	37.65	47.00	9.35	100	111	Horizontal	Pass
5	370.470	50.69	-19.08	31.61	47.00	15.39	100	340	Horizontal	Pass
6	450.010	54.79	-17.39	37.40	47.00	9.60	100	239	Horizontal	Pass

7. RADIATED EMISSION MEASUREMENT (ABOVE 1GHz)

7.1. Block Diagram of Test Setup

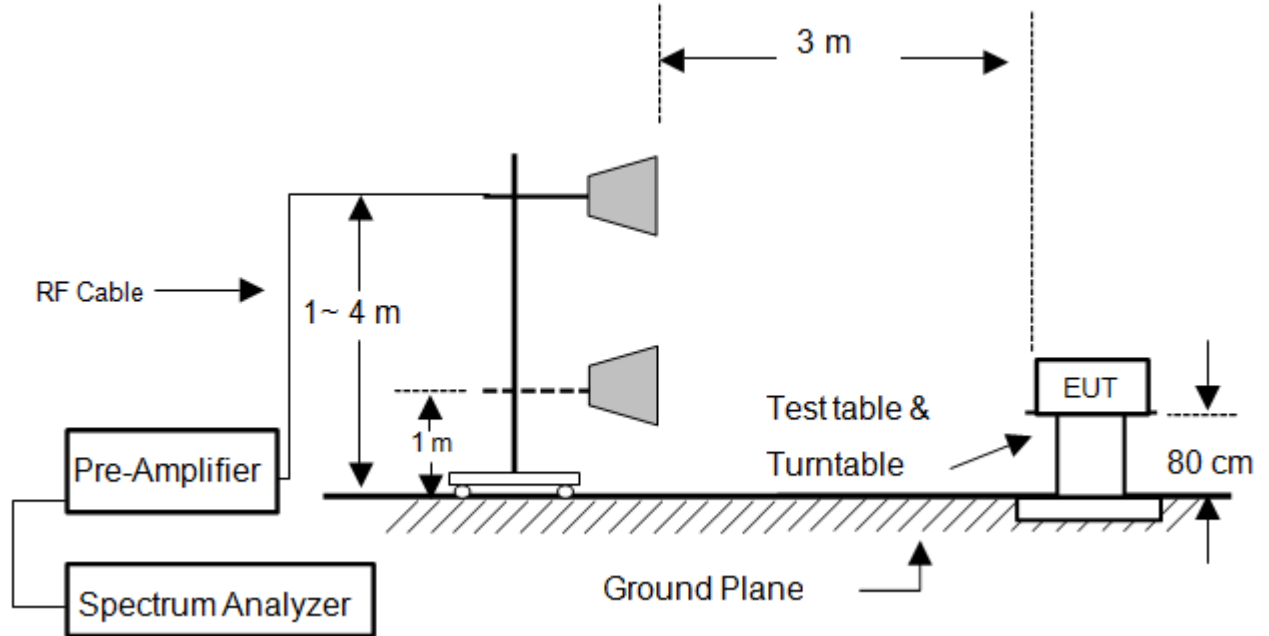

7.2. Radiated Limit

EN 55032, Class B, Table A.5

Frequency range (MHz)	Measurement			Class B limits dB(μ V/m)
	Facility	Distance (m)	Detector type/ bandwidth	
1000 to 6000	FSOATS	3	Average / 1 MHz	54
1000 to 6000			Peak / 1 MHz	74

Note: The highest internal source of an EUT is defined as the highest frequency generated or used within the EUT or on which the EUT operates or tunes. If the highest frequency of the internal sources of the EUT is less than 108 MHz, the measurement shall only be made up to 1 GHz. If the highest frequency of the internal sources of the EUT is between 108 MHz and 500 MHz the measurement shall only be made up to 2 GHz. If the highest frequency of the internal sources of the EUT is between 500 MHz and 1 GHz, the measurement shall only be made up to 5 GHz. If the highest frequency of the internal sources of the EUT is above 1 GHz, the measurement shall be made up to 5 times the highest frequency or 6 GHz, whichever is less.

7.3. Test Procedure

The EUT was placed on a non-conductive table whose total height equaled 80cm. All units of equipment forming the system under test (includes the EUT as well as connected peripherals and associated equipment or devices) shall be arranged such that a nominal 0.1 m separation is achieved between the neighboring units. Where the mains cable supplied by the manufacturer is longer than 1 m, the excess should be folded at the centre into a bundle no longer than 0.4 m, so that its length is shortened to 1 m.

The EUT was set 3 meters away from the receiving antenna that was mounted on a non-conductive mast. The antenna can move up and down between 1 to 4 meters to find out the maximum emission level.

The turntable can rotate 360 degree to determine the position of the maximum emission level.

The initial testing identified the frequency that has the highest disturbance relative to the limit while operating the EUT in typical modes of operation and cable positions in a test setup representative of typical system configuration.

The identification of the frequency of highest emission with respect to the limit was found by investigating emissions at a number of significant frequencies. The probable frequency of maximum emission had been found and that the associated cable and EUT configuration and mode of operation had been identified.

The frequency range above 1GHz the measuring instrument use RBW=1 MHz and VBW=3 MHz.

Test results were obtained from the following equation:

Measurement (dB μ V) = Correct Factor (dB) + Reading (dB μ V)

Over (dB) = Measurement (dB μ V) - Limit (dB μ V)

7.4. Measuring Results

Pass.

Please refer to the following pages.

Model DataHub1000 with adapter 1 (ABT020120A)

■ Radiated Emission Above 1GHz

Test mode: WIFI CONTROL Humidity: 55%
 Temperature: 24°C Test Voltage: AC 230V/50Hz
 Test Date: 2021-11-29

Freq. (MHz)	Ant.Pol. H/V	Emission Level(dBuV/m)		Limit 3m(dBuV/m)		Over(dB)	
		PK	AV	PK	AV	PK	AV
4049.020	V	44.10	36.20	74.00	54.00	-29.90	-17.80
4264.706	V	45.10	35.90	74.00	54.00	-28.90	-18.10
4975.490	V	47.80	39.60	74.00	54.00	-26.20	-14.40
5137.255	V	47.40	38.70	74.00	54.00	-26.60	-15.30
5583.333	V	48.30	39.60	74.00	54.00	-25.70	-14.40
5833.333	V	47.60	38.70	74.00	54.00	-26.40	-15.30
3426.470	H	44.30	35.20	74.00	54.00	-29.70	-18.80
4044.118	H	46.70	37.80	74.00	54.00	-27.30	-16.20
4818.627	H	47.40	38.60	74.00	54.00	-26.60	-15.40
5303.922	H	49.80	40.10	74.00	54.00	-24.20	-13.90
5421.569	H	50.40	41.30	74.00	54.00	-23.60	-12.70
5622.549	H	49.20	40.10	74.00	54.00	-24.80	-13.90

Test mode: WIFI CONTROL Humidity: 55%
 Temperature: 24°C Test Voltage: AC 120V/60Hz
 Test Date: 2021-11-29

Freq. (MHz)	Ant.Pol. H/V	Emission Level(dBuV/m)		Limit 3m(dBuV/m)		Over(dB)	
		PK	AV	PK	AV	PK	AV
2313.725	V	39.10	35.10	74.00	54.00	-34.90	-18.90
2936.274	V	39.90	34.20	74.00	54.00	-34.10	-19.80
3598.039	V	40.00	33.50	74.00	54.00	-34.00	-20.50
4049.020	V	41.60	36.20	74.00	54.00	-32.40	-17.80
4774.510	V	41.60	34.30	74.00	54.00	-32.40	-19.70
5500.000	V	46.70	38.10	74.00	54.00	-27.30	-15.90
2759.804	H	42.90	37.60	74.00	54.00	-31.10	-16.40
3367.647	H	43.00	38.60	74.00	54.00	-31.00	-15.40
3857.843	H	43.70	37.60	74.00	54.00	-30.30	-16.40
4534.314	H	44.50	38.10	74.00	54.00	-29.50	-15.90
4897.059	H	45.90	39.10	74.00	54.00	-28.10	-14.90
5372.549	H	46.90	39.70	74.00	54.00	-27.10	-14.30

Project Information(Model DataHub1000 with adapter 2 (BSG025W-1202000A))			
Mode:	RS485+Net Port+TF Card+WIFI	Voltage:	AC 120V/60Hz
Environment:	Temp: 25°C; Humi:60%	Engineer:	Alarak Wu

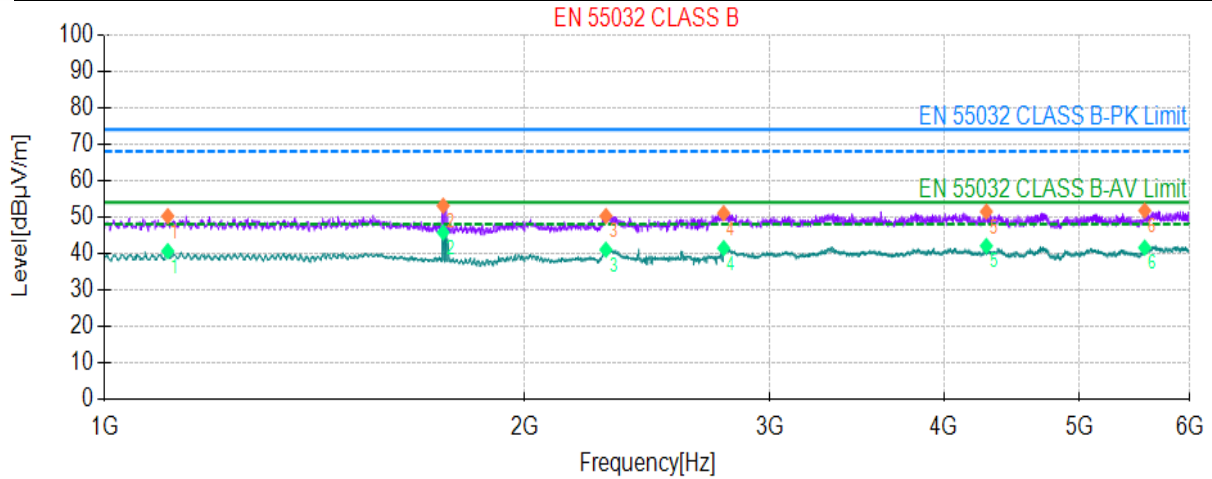

PK Final Data List										
NO.	Freq. [MHz]	PK Reading [dBµV/m]	Factor [dB]	PK Value [dBµV/m]	PK Limit [dBµV/m]	PK Margin [dB]	Height [cm]	Angle [°]	Polarity	Verdict
1	1110.022	64.23	-14.03	50.20	74.00	23.80	100	130	Vertical	Pass
2	1749.150	66.91	-13.87	53.04	74.00	20.96	100	273	Vertical	Pass
3	2288.258	63.55	-13.31	50.24	74.00	23.76	100	122	Vertical	Pass
4	2779.356	62.34	-11.36	50.98	74.00	23.02	100	250	Vertical	Pass
5	4288.658	58.58	-7.15	51.43	74.00	22.57	100	214	Vertical	Pass
6	5569.914	55.44	-3.73	51.71	74.00	22.29	100	108	Vertical	Pass

AV Final Data List										
NO.	Freq. [MHz]	AV Reading [dBµV/m]	Factor [dB]	AV Value [dBµV/m]	AV Limit [dBµV/m]	AV Margin [dB]	Height [cm]	Angle [°]	Polarity	Verdict
1	1110.022	54.61	-14.03	40.58	54.00	13.42	100	130	Vertical	Pass
2	1749.150	59.6	-13.87	45.73	54.00	8.27	100	273	Vertical	Pass
3	2288.258	54.28	-13.31	40.97	54.00	13.03	100	122	Vertical	Pass
4	2779.356	52.76	-11.36	41.40	54.00	12.60	100	250	Vertical	Pass
5	4288.658	49.15	-7.15	42.00	54.00	12.00	100	214	Vertical	Pass
6	5569.914	45.26	-3.73	41.53	54.00	12.47	100	108	Vertical	Pass

Project Information(Model DataHub1000 with adapter 2 (BSG025W-1202000A))			
Mode:	RS485+Net Port+TF Card+WIFI	Voltage:	AC 120V/60Hz
Environment:	Temp: 25°C; Humi:60%	Engineer:	Alarak Wu

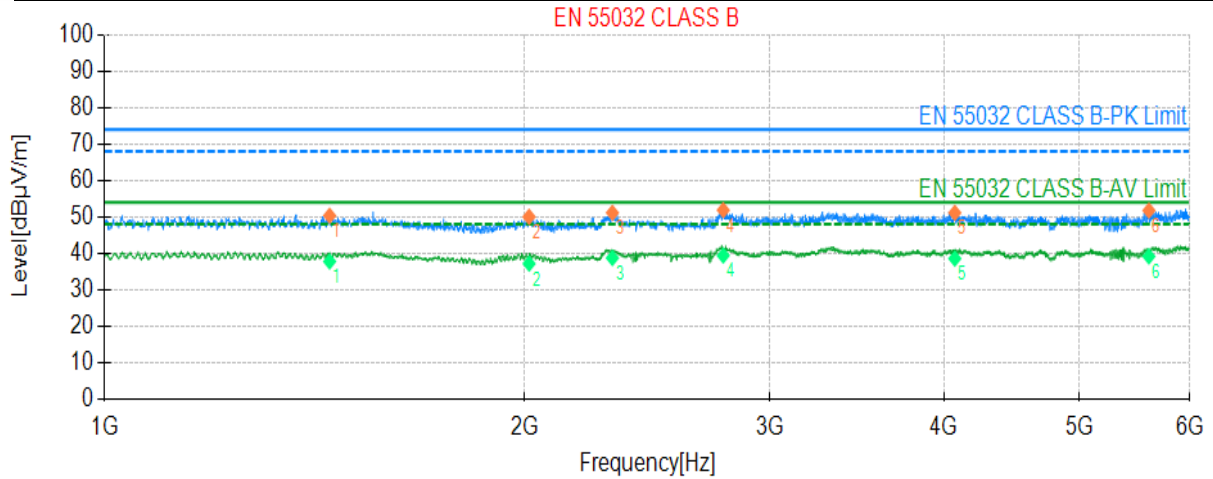

PK Final Data List										
NO.	Freq. [MHz]	PK Reading [dBµV/m]	Factor [dB]	PK Value [dBµV/m]	PK Limit [dBµV/m]	PK Margin [dB]	Height [cm]	Angle [°]	Polarity	Verdict
1	1450.124	64.42	-14.10	50.32	74.00	23.68	100	146	Horizontal	Pass
2	2015.676	63.60	-13.60	50.00	74.00	24.00	100	50.2	Horizontal	Pass
3	2313.046	64.38	-13.28	51.10	74.00	22.90	100	71	Horizontal	Pass
4	2777.425	63.20	-11.37	51.83	74.00	22.17	100	69	Horizontal	Pass
5	4070.598	58.58	-7.48	51.10	74.00	22.90	100	34	Horizontal	Pass
6	5608.863	55.25	-3.54	51.71	74.00	22.29	100	152	Horizontal	Pass

AV Final Data List										
NO.	Freq. [MHz]	AV Reading [dBµV/m]	Factor [dB]	AV Value [dBµV/m]	AV Limit [dBµV/m]	AV Margin [dB]	Height [cm]	Angle [°]	Polarity	Verdict
1	1450.124	51.82	-14.10	37.72	54.00	16.28	100	146	Horizontal	Pass
2	2015.676	50.72	-13.60	37.12	54.00	16.88	100	50.2	Horizontal	Pass
3	2313.046	51.97	-13.28	38.69	54.00	15.31	100	71	Horizontal	Pass
4	2777.425	50.73	-11.37	39.36	54.00	14.64	100	69	Horizontal	Pass
5	4070.598	46.01	-7.48	38.53	54.00	15.47	100	34	Horizontal	Pass
6	5608.863	42.67	-3.54	39.13	54.00	14.87	100	152	Horizontal	Pass

Project Information(Model DataHub1000 with adapter 2 (BSG025W-1202000A))			
Mode:	RS485+Net Port+TF Card+WIFI	Voltage:	AC 230V/50Hz
Environment:	Temp: 25°C; Humi:60%	Engineer:	Alarak Wu

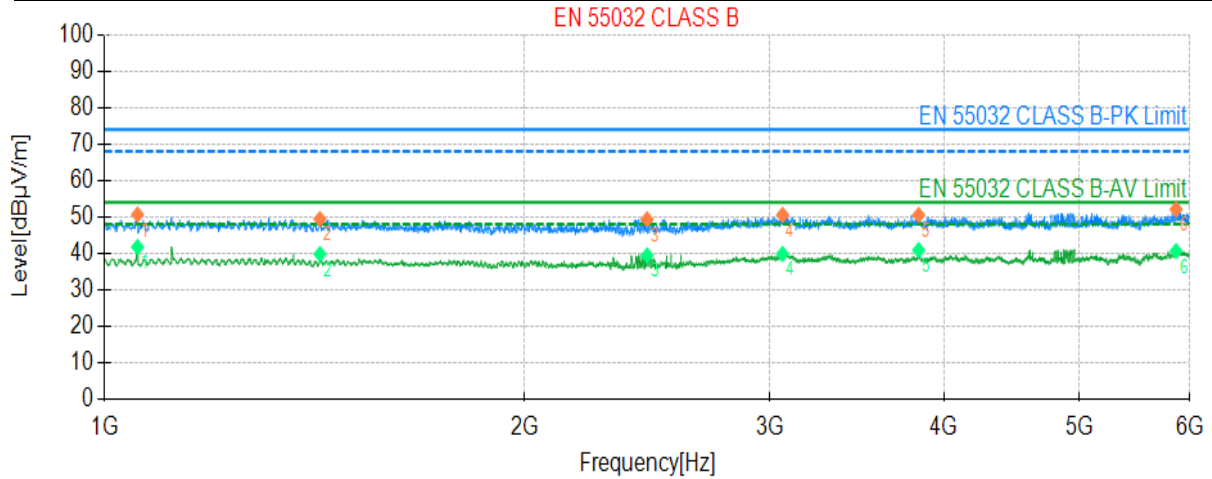

PK Final Data List										
NO.	Freq. [MHz]	PK Reading [dBµV/m]	Factor [dB]	PK Value [dBµV/m]	PK Limit [dBµV/m]	PK Margin [dB]	Height [cm]	Angle [°]	Polarity	Verdict
1	1056.011	64.64	-14.02	50.62	74.00	23.38	100	73	Horizontal	Pass
2	1427.085	63.46	-14.10	49.36	74.00	24.64	100	193	Horizontal	Pass
3	2449.290	62.45	-13.14	49.31	74.00	24.69	100	4	Horizontal	Pass
4	3063.413	60.43	-9.90	50.53	74.00	23.47	100	310	Horizontal	Pass
5	3834.567	58.61	-8.11	50.50	74.00	23.50	100	59	Horizontal	Pass
6	5865.973	54.27	-2.23	52.04	74.00	21.96	100	200	Horizontal	Pass

AV Final Data List										
NO.	Freq. [MHz]	AV Reading [dBµV/m]	Factor [dB]	AV Value [dBµV/m]	AV Limit [dBµV/m]	AV Margin [dB]	Height [cm]	Angle [°]	Polarity	Verdict
1	1056.011	55.71	-14.02	41.69	54.00	12.31	100	73	Horizontal	Pass
2	1427.085	53.85	-14.10	39.75	54.00	14.25	100	193	Horizontal	Pass
3	2449.290	52.53	-13.14	39.39	54.00	14.61	100	4	Horizontal	Pass
4	3063.413	49.69	-9.90	39.79	54.00	14.21	100	310	Horizontal	Pass
5	3834.567	48.99	-8.11	40.88	54.00	13.12	100	59	Horizontal	Pass
6	5865.973	42.82	-2.23	40.59	54.00	13.41	100	200	Horizontal	Pass

Project Information(Model DataHub1000 with adapter 2 (BSG025W-1202000A))			
Mode:	RS485+Net Port+TF Card+WIFI	Voltage:	AC 230V/50Hz
Environment:	Temp: 25°C; Humi:60%	Engineer:	Alarak Wu

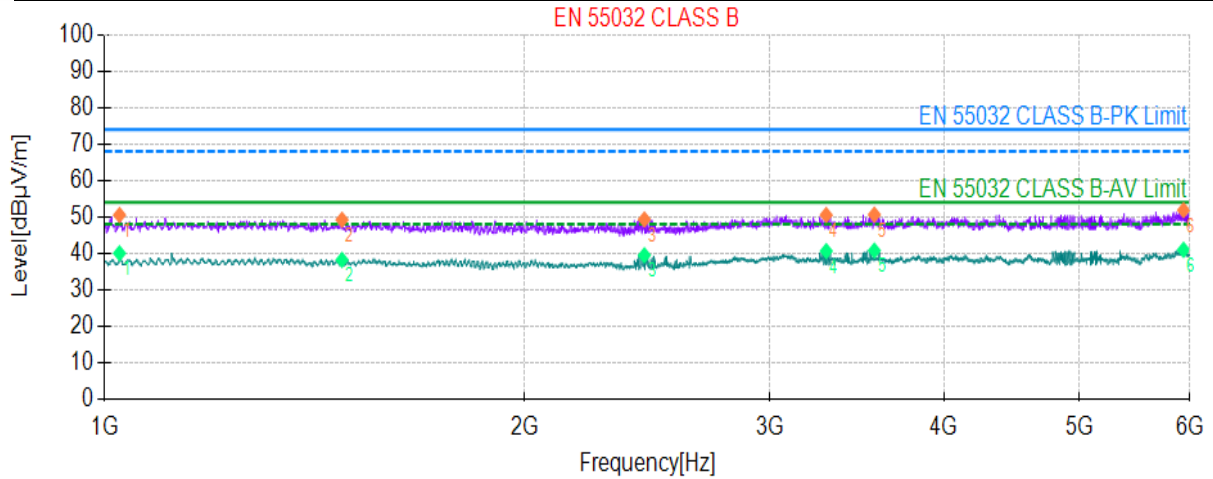

PK Final Data List										
NO.	Freq. [MHz]	PK Reading [dBµV/m]	Factor [dB]	PK Value [dBµV/m]	PK Limit [dBµV/m]	PK Margin [dB]	Height [cm]	Angle [°]	Polarity	Verdict
1	1025.005	64.53	-14.02	50.51	74.00	23.49	100	283	Vertical	Pass
2	1480.096	63.29	-14.11	49.18	74.00	24.82	100	8	Vertical	Pass
3	2438.288	62.43	-13.15	49.28	74.00	24.72	100	264	Vertical	Pass
4	3292.459	60.03	-9.53	50.50	74.00	23.50	100	290	Vertical	Pass
5	3564.513	59.57	-8.98	50.59	74.00	23.41	100	120	Vertical	Pass
6	5938.988	53.68	-1.86	51.82	74.00	22.18	100	48	Vertical	Pass

AV Final Data List										
NO.	Freq. [MHz]	AV Reading [dBµV/m]	Factor [dB]	AV Value [dBµV/m]	AV Limit [dBµV/m]	AV Margin [dB]	Height [cm]	Angle [°]	Polarity	Verdict
1	1025.005	54.00	-14.02	39.98	54.00	14.02	100	283	Vertical	Pass
2	1480.096	52.28	-14.11	38.17	54.00	15.83	100	8	Vertical	Pass
3	2438.288	52.58	-13.15	39.43	54.00	14.57	100	264	Vertical	Pass
4	3292.459	50.12	-9.53	40.59	54.00	13.41	100	290	Vertical	Pass
5	3564.513	49.72	-8.98	40.74	54.00	13.26	100	120	Vertical	Pass
6	5938.988	42.79	-1.86	40.93	54.00	13.07	100	48	Vertical	Pass

8. HARMONIC CURRENT EMISSION MEASUREMENT

8.1. Block Diagram of Test Setup

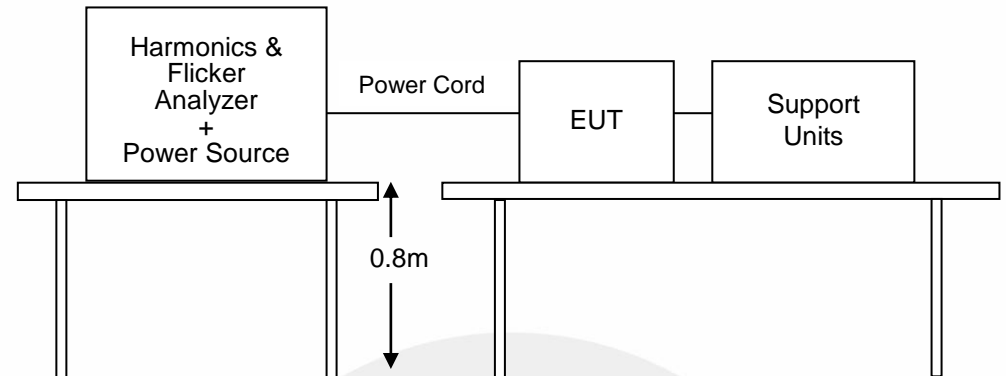

8.2. Standard Limits

EN IEC 61000-3-2, CLASS A

Harmonic current emissions evaluate the potential for the EUT to cause distortion on the AC power lines. It is applicable to electrical and electronic equipment having an input current ≤ 16 A per phase, and intended to be connected to public low-voltage distribution systems

Table 1 - Limits for Class A equipment

Harmonic order n	Maximum permissible harmonic current (A)
Odd harmonics	
3	2.30
5	1.14
7	0.77
9	0.40
11	0.33
13	0.21
$15 \leq n \leq 39$	$0.15 \frac{0.15}{n}$
Even harmonics	
2	1.08
4	0.43
6	0.30
$8 \leq n \leq 40$	$0.23 \frac{8}{n}$

8.3. Test Procedure

The measurement of harmonic currents shall be performed as follows: i. For each harmonic order, measure the 1.5 s smoothed r.m.s. harmonic current in each DFT time window as defined in EN / IEC 61000-4-7:2009. ii. Calculate the arithmetic average of the measured values from the DFT time windows, over the entire observation period Short cyclic ($T \text{ cycle} \leq 2.5 \text{ min}$). Because of synchronisation to meet the requirements for repeatability in 5%.

8.4. Test Results

Pass.

Please refer to the following pages.



Harmonics – Class-A per IEC 61000-3-2 (Run time)

EUT: DataHub(DataHub1000 with adapter 1 (ABT020120A)) Tested by: LSL
 Test category: Class-A (European limits) Test Margin: 100
 Test date: 2021/12/1 Start time: 10:36:19 End time: 10:39:00
 Test duration (min): 2.5 Data file name: H-000222.cts_data
 Comment: WIFI CONTROL
 Customer: Customer

Test Result: Pass **Source qualification: Normal**

Current & voltage waveforms

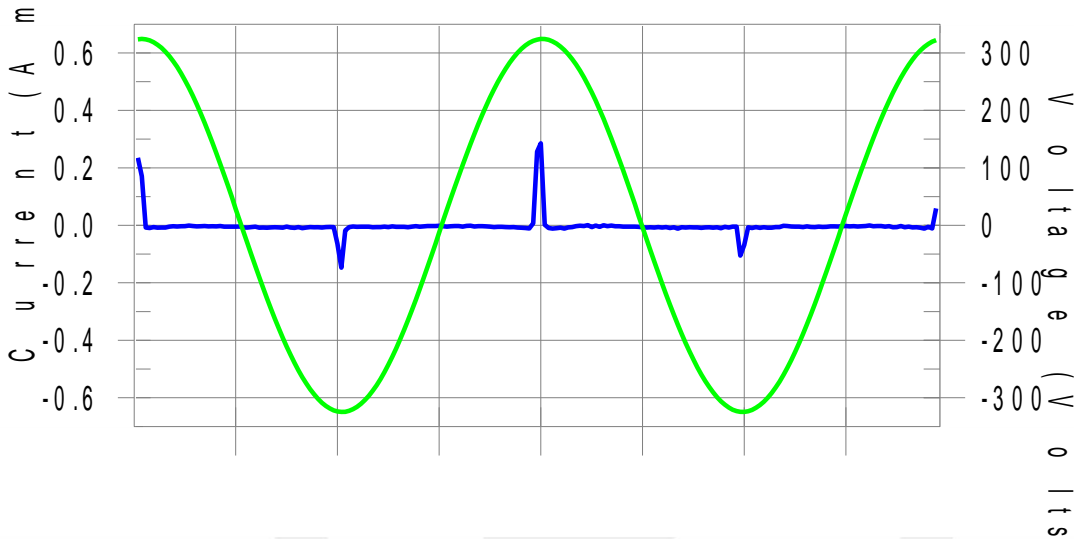

Harmonics and Class A limit line

European Limits

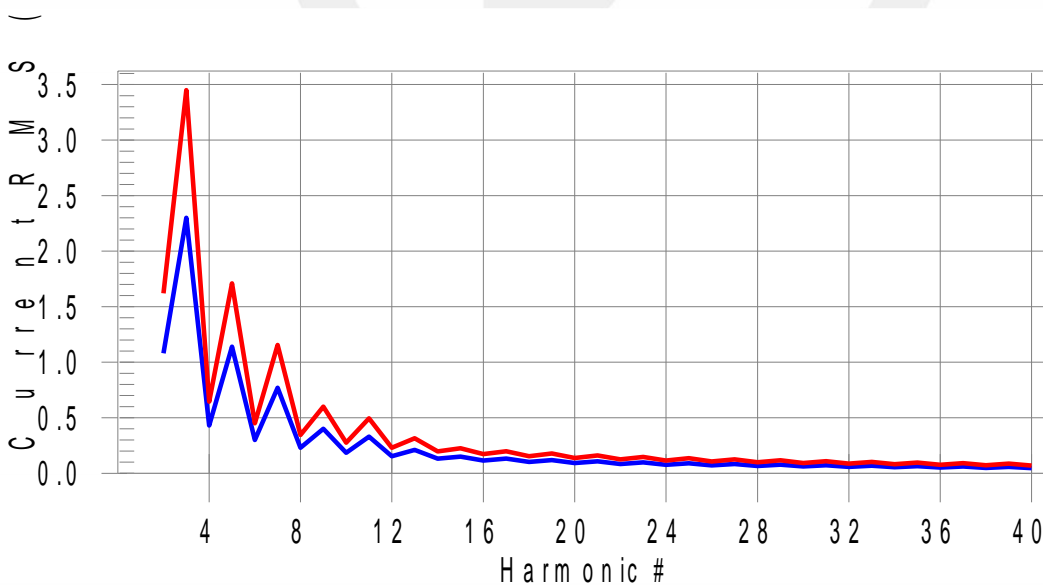

Test result: Pass **Worst harmonics H23-3.8% of 150% limit, H23-5.5% of 100% limit**

Current Test Result Summary (Run time)

EUT: DataHub(DataHub1000 with adapter 1 (ABT020120A)) Tested by: LSL
 Test category: Class-A (European limits) Test Margin: 100
 Test date: 2021/12/1 Start time: 10:36:19 End time: 10:39:00
 Test duration (min): 2.5 Data file name: H-000222.cts_data
 Comment: WIFI CONTROL
 Customer: Customer

Test Result: Pass Source qualification: Normal
 THC(A): 0.030 I-THD(%): 357.5 POHC(A): 0.013 POHC Limit(A): 0.251

Highest parameter values during test:

V_RMS (Volts): 229.72 Frequency(Hz): 50.00
 I_Peak (Amps): 0.335 I_RMS (Amps): 0.034
 I_Fund (Amps): 0.008 Crest Factor: 10.304
 Power (Watts): 1.9 Power Factor: 0.263

Harm#	Harms(avg)	100%Limit	%of Limit	Harms(max)	150%Limit	%of Limit	Status
2	0.005	1.080	N/A	0.006	1.620	N/A	Pass
3	0.008	2.300	0.3	0.009	3.450	0.3	Pass
4	0.005	0.430	N/A	0.005	0.645	N/A	Pass
5	0.008	1.140	0.7	0.008	1.710	0.5	Pass
6	0.005	0.300	N/A	0.005	0.450	N/A	Pass
7	0.008	0.770	1.0	0.008	1.155	0.7	Pass
8	0.004	0.230	N/A	0.005	0.345	N/A	Pass
9	0.007	0.400	1.8	0.008	0.600	1.3	Pass
10	0.004	0.184	N/A	0.005	0.276	N/A	Pass
11	0.007	0.330	2.2	0.008	0.495	1.6	Pass
12	0.004	0.153	N/A	0.005	0.230	N/A	Pass
13	0.007	0.210	3.3	0.007	0.315	2.3	Pass
14	0.004	0.131	N/A	0.005	0.197	N/A	Pass
15	0.007	0.150	4.4	0.007	0.225	3.1	Pass
16	0.004	0.115	N/A	0.004	0.173	N/A	Pass
17	0.006	0.132	4.8	0.007	0.198	3.4	Pass
18	0.004	0.102	N/A	0.004	0.153	N/A	Pass
19	0.006	0.118	5.1	0.006	0.178	3.6	Pass
20	0.004	0.092	N/A	0.004	0.138	N/A	Pass
21	0.006	0.107	5.3	0.006	0.161	3.7	Pass
22	0.004	0.084	N/A	0.004	0.125	N/A	Pass
23	0.005	0.098	5.5	0.006	0.147	3.8	Pass
24	0.003	0.077	N/A	0.004	0.115	N/A	Pass
25	0.005	0.090	N/A	0.005	0.135	N/A	Pass
26	0.003	0.071	N/A	0.003	0.107	N/A	Pass
27	0.005	0.083	N/A	0.005	0.125	N/A	Pass
28	0.003	0.066	N/A	0.003	0.099	N/A	Pass
29	0.004	0.078	N/A	0.004	0.116	N/A	Pass
30	0.003	0.061	N/A	0.003	0.092	N/A	Pass
31	0.004	0.073	N/A	0.004	0.109	N/A	Pass
32	0.003	0.058	N/A	0.003	0.086	N/A	Pass
33	0.003	0.068	N/A	0.004	0.102	N/A	Pass
34	0.002	0.054	N/A	0.003	0.081	N/A	Pass
35	0.003	0.064	N/A	0.003	0.096	N/A	Pass
36	0.002	0.051	N/A	0.002	0.077	N/A	Pass
37	0.003	0.061	N/A	0.003	0.091	N/A	Pass
38	0.002	0.048	N/A	0.002	0.073	N/A	Pass
39	0.002	0.058	N/A	0.002	0.087	N/A	Pass
40	0.002	0.046	N/A	0.002	0.069	N/A	Pass

Voltage Source Verification Data (Run time)

EUT: DataHub(DataHub1000 with adapter 1 (ABT020120A)) Tested by: LSL
 Test category: Class-A (European limits) Test Margin: 100
 Test date: 2021/12/1 Start time: 10:36:19 End time: 10:39:00
 Test duration (min): 2.5 Data file name: H-000222.cts_data
 Comment: WIFI CONTROL
 Customer: Customer

Test Result: Pass Source qualification: Normal

Highest parameter values during test:

Voltage (Vrms):	229.72	Frequency(Hz):	50.00
I_Peak (Amps):	0.335	I_RMS (Amps):	0.034
I_Fund (Amps):	0.008	Crest Factor:	10.304
Power (Watts):	1.9	Power Factor:	0.263

Harm#	Harmonics V-rms	Limit V-rms	% of Limit	Status
2	0.081	0.459	17.66	OK
3	0.587	2.067	28.38	OK
4	0.057	0.459	12.47	OK
5	0.069	0.919	7.49	OK
6	0.022	0.459	4.78	OK
7	0.024	0.689	3.54	OK
8	0.018	0.459	3.85	OK
9	0.039	0.459	8.49	OK
10	0.010	0.459	2.11	OK
11	0.020	0.230	8.82	OK
12	0.010	0.230	4.25	OK
13	0.014	0.230	6.13	OK
14	0.006	0.230	2.52	OK
15	0.013	0.230	5.45	OK
16	0.009	0.230	3.97	OK
17	0.009	0.230	4.11	OK
18	0.010	0.230	4.27	OK
19	0.011	0.230	4.99	OK
20	0.015	0.230	6.70	OK
21	0.011	0.230	4.71	OK
22	0.009	0.230	3.80	OK
23	0.009	0.230	3.89	OK
24	0.005	0.230	2.30	OK
25	0.009	0.230	3.84	OK
26	0.005	0.230	2.13	OK
27	0.007	0.230	3.13	OK
28	0.005	0.230	2.34	OK
29	0.009	0.230	3.77	OK
30	0.005	0.230	2.20	OK
31	0.007	0.230	3.22	OK
32	0.005	0.230	2.08	OK
33	0.008	0.230	3.32	OK
34	0.005	0.230	1.99	OK
35	0.007	0.230	2.99	OK
36	0.004	0.230	1.92	OK
37	0.007	0.230	3.10	OK
38	0.004	0.230	1.77	OK
39	0.007	0.230	3.21	OK
40	0.008	0.230	3.33	OK

EUT: Datahub(Datahub1000 with adapter 2 (BSG025W-1202000A))
 Test Standard: Test per IEC 61000-3-2 Ed. 5.1 : 2020
 Test Class: (Class A Test) - Inter-Harmonics Enabled
 Test Result: **PASS**
 Test Date: 2022/5/16
 Start Time: 8:46:56
 Stop Time: 8:49:37
 Test Duration (min): 2.5

Source Qualification: Compliance with IEC 61000-3-2 Ed. 5.1 : 2020

Power Source Distortion: **OK**

Customer: Customer
 Test By: Conan Wen
 Comments: RS485+Net Port+TF Card+WIFI

General Test Data: (Phase A)

Vrms (Volts)/V-pk/V-CF:	229.23 / 323.4 / 1.411	Frequency (Hz):	50.0001
I_rms (Amps):	0.024	Power (VA)/VAR:	5.6 / 5.4
I_fund (Amps):	0.007	Power (W):	1.5
I_peak (Amps)/I-CF:	0.326 / 9.633	Power Factor:	0.276
V-THD (%):	0.05	I-THD (%):	314.80
POHC (A):	0.010 (method C.3)	POHC Limit (A):	0.250
I-THC (A):	0.021	Meas. Pwr (Min / Max)	1.4W/1.9W
Phase angle of H5 (deg):	7.9		

Harmonic Spectrum

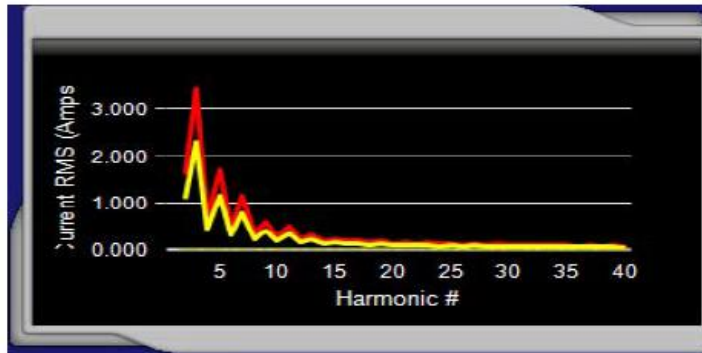

Voltage & Current Waveform

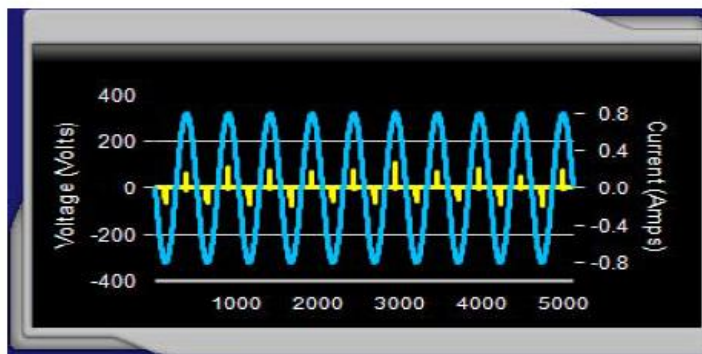

Current Harmonics (values at the end of test)

Harm No.	Harm. Ave.	Harm. Limit (100%)	% Of Limits	Result (Ave.)	Result (Max.)	Harm. Win.	Harm. Win. (150%)	% Of Max
2	0.0005	1.0800	0.0	PASS	PASS	0.0006	1.6200	0.0
3	0.0073	2.3000	0.3	PASS	PASS	0.0077	3.4500	0.2
4	0.0006	0.4300	0.1	PASS	PASS	0.0007	0.6450	0.1
5	0.0070	1.1400	0.6	PASS	PASS	0.0074	1.7100	0.4
6	0.0006	0.3000	0.2	PASS	PASS	0.0007	0.4500	0.2
7	0.0070	0.7700	0.9	PASS	PASS	0.0073	1.1550	0.6
8	0.0006	0.2300	0.3	PASS	PASS	0.0007	0.3450	0.2
9	0.0067	0.4000	1.7	PASS	PASS	0.0071	0.6000	1.2
10	0.0006	0.1840	0.3	PASS	PASS	0.0007	0.2760	0.3
11	0.0065	0.3300	2.0	PASS	PASS	0.0068	0.4950	1.4
12	0.0006	0.1530	0.4	PASS	PASS	0.0007	0.2295	0.3
13	0.0062	0.2100	3.0	PASS	PASS	0.0065	0.3150	2.1
14	0.0006	0.1310	0.5	PASS	PASS	0.0007	0.1965	0.4
15	0.0059	0.1500	3.9	PASS	PASS	0.0062	0.2250	2.7
16	0.0006	0.1150	0.5	PASS	PASS	0.0007	0.1725	0.4
17	0.0055	0.1320	4.2	PASS	PASS	0.0058	0.1980	2.9
18	0.0006	0.1020	0.6	PASS	PASS	0.0007	0.1530	0.5
19	0.0052	0.1180	4.4	PASS	PASS	0.0054	0.1770	3.1
20	0.0006	0.0920	0.7	PASS	PASS	0.0007	0.1380	0.5
21	0.0048	0.1070	4.5	PASS	PASS	0.0050	0.1605	3.1
22	0.0006	0.0830	0.7	PASS	PASS	0.0007	0.1245	0.6
23	0.0044	0.0970	4.5	PASS	PASS	0.0046	0.1455	3.1
24	0.0006	0.0760	0.8	PASS	PASS	0.0007	0.1140	0.6
25	0.0040	0.0900	4.4	PASS	PASS	0.0041	0.1350	3.1
26	0.0006	0.0700	0.8	PASS	PASS	0.0007	0.1050	0.6
27	0.0036	0.0830	4.3	PASS	PASS	0.0037	0.1245	3.0
28	0.0006	0.0650	0.9	PASS	PASS	0.0007	0.0975	0.7
29	0.0032	0.0770	4.1	PASS	PASS	0.0033	0.1155	2.8
30	0.0006	0.0610	1.0	PASS	PASS	0.0007	0.0915	0.7
31	0.0028	0.0720	3.9	PASS	PASS	0.0029	0.1080	2.7
32	0.0006	0.0570	1.0	PASS	PASS	0.0007	0.0855	0.8
33	0.0024	0.0680	3.5	PASS	PASS	0.0025	0.1020	2.5
34	0.0006	0.0540	1.1	PASS	PASS	0.0007	0.0810	0.9
35	0.0021	0.0640	3.2	PASS	PASS	0.0022	0.0960	2.3
36	0.0006	0.0510	1.2	PASS	PASS	0.0007	0.0765	0.9
37	0.0017	0.0600	2.9	PASS	PASS	0.0018	0.0900	2.0
38	0.0006	0.0480	1.2	PASS	PASS	0.0007	0.0720	0.9
39	0.0014	0.0570	2.5	PASS	PASS	0.0016	0.0855	1.8
40	0.0004	0.0460	1.0	PASS	PASS	0.0005	0.0690	0.7

Power Source Verification Data

Harm No.	Harm. Value	Harm. Limit	% Of Limits	% Of Vfund	Result
2	0.034	0.460	7.387	0.015	OK
3	0.099	2.070	4.762	0.043	OK
4	0.022	0.460	4.874	0.010	OK
5	0.065	0.920	7.100	0.028	OK
6	0.027	0.460	5.954	0.012	OK
7	0.030	0.690	4.379	0.013	OK
8	0.046	0.460	9.960	0.020	OK
9	0.023	0.460	5.027	0.010	OK
10	0.028	0.460	6.190	0.012	OK
11	0.026	0.230	11.222	0.011	OK
12	0.029	0.230	12.603	0.013	OK
13	0.017	0.230	7.505	0.008	OK
14	0.031	0.230	13.293	0.013	OK
15	0.016	0.230	7.168	0.007	OK
16	0.014	0.230	5.895	0.006	OK
17	0.019	0.230	8.341	0.008	OK
18	0.017	0.230	7.550	0.008	OK
19	0.019	0.230	8.137	0.008	OK
20	0.021	0.230	9.306	0.009	OK
21	0.016	0.230	6.761	0.007	OK
22	0.021	0.230	9.022	0.009	OK
23	0.015	0.230	6.451	0.006	OK
24	0.020	0.230	8.653	0.009	OK
25	0.017	0.230	7.438	0.007	OK
26	0.016	0.230	7.057	0.007	OK
27	0.018	0.230	7.820	0.008	OK
28	0.016	0.230	6.970	0.007	OK
29	0.016	0.230	6.749	0.007	OK
30	0.018	0.230	7.995	0.008	OK
31	0.018	0.230	7.784	0.008	OK
32	0.024	0.230	10.532	0.011	OK
33	0.015	0.230	6.517	0.007	OK
34	0.022	0.230	9.552	0.010	OK
35	0.015	0.230	6.652	0.007	OK
36	0.020	0.230	8.583	0.009	OK
37	0.015	0.230	6.624	0.007	OK
38	0.019	0.230	8.114	0.008	OK
39	0.014	0.230	6.183	0.006	OK
40	0.018	0.230	7.723	0.008	OK

9. VOLTAGE FLUCTUATION AND FLICKER MEASUREMENT

9.1. Block Diagram of Test Setup

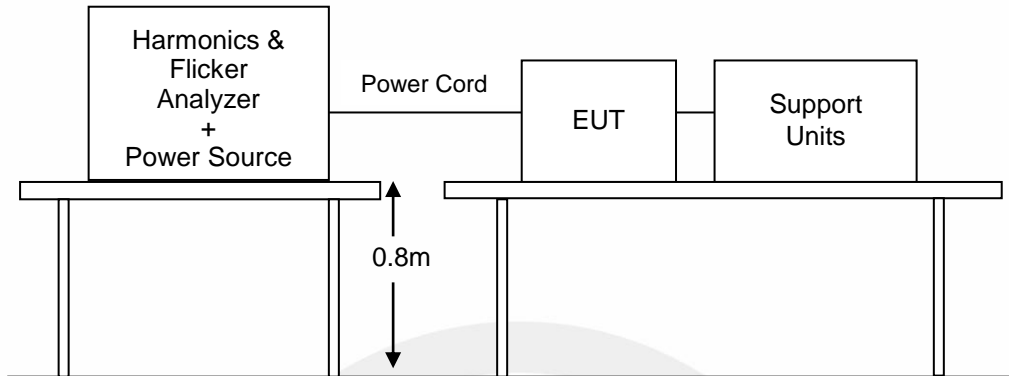

9.2. Standard Limits

EN 61000-3-3 Limits

The objective of voltage changes, voltage fluctuations and flicker in public low voltage supply systems during equipment with rated current ≤ 16 A per phase, ensures that home appliances and certain other electrical equipment do not adversely affect lighting equipment when connected to the same power system.

Voltage Fluctuation and Flicker Limits:

- the value of P_{st} shall not be greater than 1.0;
- the value of Plt shall not be greater than 0.65;
- the value of $d(t)$ during a voltage change shall not exceed 3.3 % for more than 500 ms;
- the relative steady-state voltage change, dc , shall not exceed 3.3 %;
- the maximum relative voltage change, d_{max} , shall not exceed 4.0 %;

9.3. Test Procedure

The total impedance of the test circuit, excluding the appliance under test, but including the internal impedance of the supply source, shall be equal to the reference impedance. The stability and tolerance of the reference impedance shall be adequate to ensure that the overall accuracy of 8% is achieved during the whole assessment procedure.

9.4. Test Results

Pass.

Please refer to the following pages.

Flicker Test Summary per IEC61000-3-3 (Run time)

EUT: DataHub(DataHub1000 with adapter 1 (ABT020120A)) **Tested by: LSL**
Test category: dt,dmax,dc and Pst (European limits) **Test Margin: 100**
Test date: 2021/12/1 **Start time: 10:39:53** **End time: 10:50:21**
Test duration (min): 10 **Data file name: F-000223.cts_data**
Comment: WIFI CONTROL
Customer: Customer

Test Result: Pass

Status: Test Completed

Pst_i and limit line

European Limits

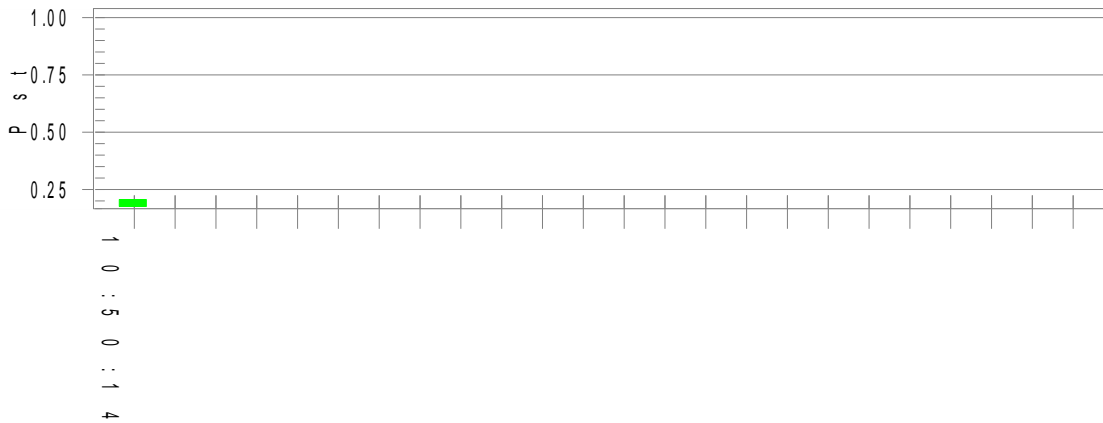

Plt and limit line



Parameter values recorded during the test:

Vrms at the end of test (Volt):	229.62		
Highest dt (%):		Test limit (%):	
T-max (mS):	0	Test limit (mS):	500.0 Pass
Highest dc (%):	0.00	Test limit (%):	3.30 Pass
Highest dmax (%):	0.00	Test limit (%):	4.00 Pass
Highest Pst (10 min. period):	0.206	Test limit:	1.000 Pass

EUT: Datahub(Datahub1000 with adapter 2 (BSG025W-1202000A))
Test Standard: Test per IEC 61000-3-3 Ed. 3.1 : 2017
Test Class: Flicker Test, Pst-dc-dmax-Tmax
Test Result: **PASS**
Test Date: 2022/5/16
Start Time: 8:51:46
Stop Time: 9:02:03
Test Duration (min): 10

Source Qualification: Compliance with IEC 61000-3-3 Ed. 3.1 : 2017
Customer: Customer
Test By: Conan Wen
Comments: RS485+Net Port+TF Card+WIFI

Phase A

Vrms (Volts):	229.27	Frequency (Hz):	50.00
I _{rms} (Amps):	0.022	Power (W):	1.5
V-THD (%):	0.064	T-Max (ms):	0 (500)
dmax (%):	0.000 (4.000)	Hi dmax (%):	0.000 (4.000)
dc (%):	0.000 (3.300)	Hi dc (%):	0.000 (3.300)
Pst-1 :	0.039 (1.000)		
Plt :	0.017 (0.650)		

Pst Spectrum

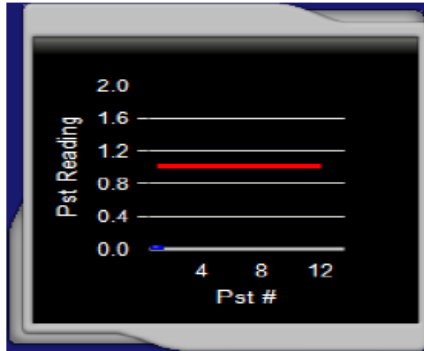

Plt Spectrum

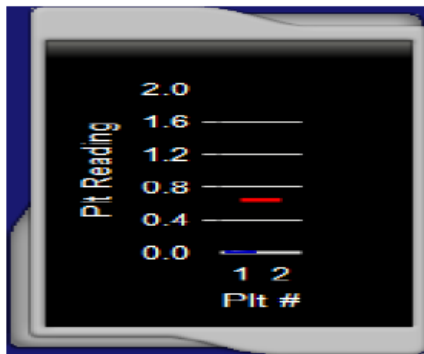

10. IMMUNITY GENERAL PERFORMANCE CRITERIA DESCRIPTION

General performance criteria are defined in EN 55035 clause 8.2, 8.3 and 8.4. These criteria shall be used during the testing of primary functions where no relevant annex is applicable.

When assessing the impact of a disturbance on a function, the assessment should take into consideration the function's performance prior to the application of the disturbance and only identify as failures those changes in performance that are a result of the disturbance.

EN 55035:

Performance criterion A

The equipment shall continue to operate as intended without operator intervention. No degradation of performance, loss of function or change of operating state is allowed below a performance level specified by the manufacturer when the equipment is used as intended. The performance level may be replaced by a permissible loss of performance. If the minimum performance level or the permissible performance loss is not specified by the manufacturer, then either of these may be derived from the product description and documentation, and by what the user may reasonably expect from the equipment if used as intended.

Performance criterion B

During the application of the disturbance, degradation of performance is allowed. However, no unintended change of actual operating state or stored data is allowed to persist after the test.

After the test, the equipment shall continue to operate as intended without operator intervention; no degradation of performance or loss of function is allowed, below a performance level specified by the manufacturer, when the equipment is used as intended. The performance level may be replaced by a permissible loss of performance.

If the minimum performance level (or the permissible performance loss), or recovery time, is not specified by the manufacturer, then either of these may be derived from the product description and documentation, and by what the user may reasonably expect from the equipment if used as intended.

Performance criterion C

Loss of function is allowed, provided the function is self-recoverable, or can be restored by the operation of the controls by the user in accordance with the manufacturer's instructions. A reboot or re-start operation is allowed. Information stored in non-volatile memory, or protected by a battery backup, shall not be lost.

11. ELECTROSTATIC DISCHARGE

11.1. Test Specification

Test standard	: EN 55035
Basic standard	: IEC 61000-4-2
Performance criterion	: B
Test level	: ±8.0kV (Air discharge) ±4.0kV (Contact discharge)

11.2. Block Diagram of Test Setup

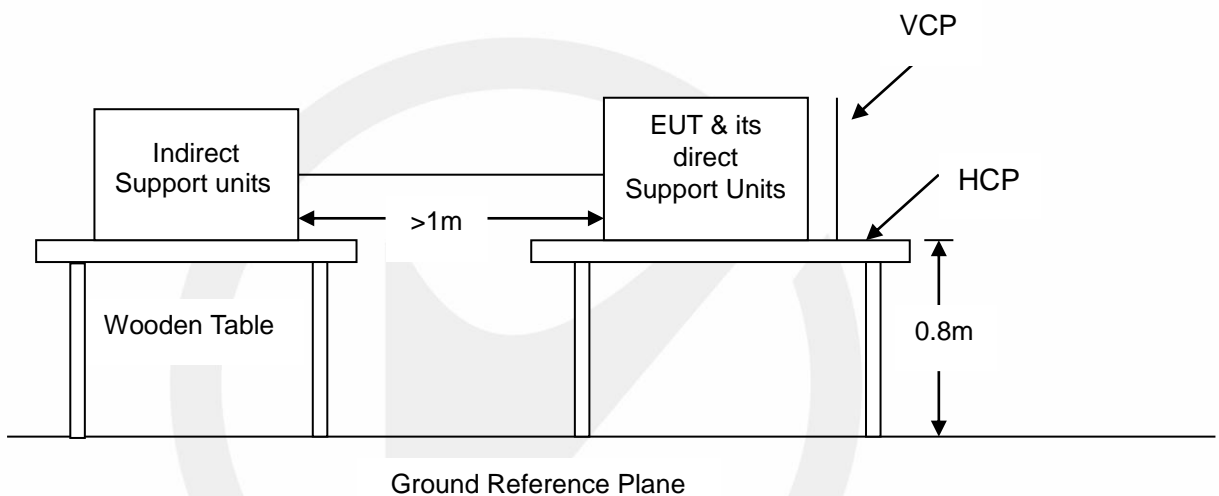

11.3. Test Procedure

- In the case of air discharge testing, the climatic conditions shall be within the following ranges:
 - ambient temperature: 15°C to 35°C;
 - relative humidity : 30% to 60%;
 - atmospheric pressure : 86 kPa (860 mbar) to 106 kPa (1060 mbar)
- Test programs and software shall be chosen so as to exercise all normal modes of operation of the EUT. The use of special exercising software is encouraged, but permitted only where it can be shown that the EUT is being comprehensively exercised.
- In the case of contact discharges, the tip of the discharge electrode shall touch the EUT before the discharge switch is operated.
- In the case of painted surface covering a conducting substrate, the following procedure shall be adopted :
 - If the coating is not declared to be an insulating coating by the equipment manufacturer, then the pointed tip of the generator shall penetrate the coating so as to make contact with the conducting substrate.
 - Coating declared as insulating by the manufacturer shall only be submitted to the air discharge.
 - The contact discharge test shall not be applied to such surfaces.
- In the case of air discharges, the round discharge tip of the discharge electrode shall be approached as fast as possible (without causing mechanical damage) to touch the EUT. After each discharge, the ESD generator (discharge electrode) shall be removed from the EUT. The generator is then retriggered for a new single discharge. This procedure shall be repeated until the discharges are completed. In the case of an air discharge test, the discharge switch, which is used for contact discharge, shall be closed.

- f. The test voltage shall be increased from the minimum to the selected test severity level, in order to determine any threshold of failure. The final test level should not exceed the product specification value in order to avoid damage to the equipment.
- g. The test shall be performed with both air discharge and contact discharge. The test shall be performed with single discharges. On each pre-selected point at least 10 single discharges (in the most sensitive polarity) shall be applied. For the time interval between successive single discharges an initial value of 1 s is recommended. Longer intervals may be necessary to determine whether a system failure has occurred.
- h. Ensure that the applied charge on the EUT has been dis-charged before next ESD pulse.

11.4. Test Results

Pass.

Model DataHub1000 with adapter 1 (ABT020120A)

Temperature : 22 °C
 Humidity : 47 %
 Atmospheric Pressure : 101kpa
 Test Engineer : LSL
 Test Date : 2021-12-01

Air Discharge:

Test Voltage	Location	Actual criterion	Required performance criterion	Result (Pass/Fail)
±2; 4; 8 kV	Non-Conducted Enclosure	A	B	Pass
±2; 4; 8 kV	/	/	B	/
±2; 4; 8 kV	/	/	B	/

Contact Discharge

Test Voltage	Location	Actual criterion	Required performance criterion	Result (Pass/Fail)
±2; 4kV	Conducted Enclosure	A	B	Pass
±2; 4kV	Screw	A	B	Pass
±2; 4kV	All slots of the EUT	A	B	Pass

Indirect Discharge

Test Voltage	Location	Actual criterion	Required performance criterion	Result (Pass/Fail)
±2; 4 kV	HCP	A	B	Pass
±2; 4kV	VCP	A	B	Pass

Model DataHub1000 with adapter 2 (BSG025W-1202000A)

Temperature : 23 °C
 Humidity : 57 %
 Atmospheric Pressure : 101kpa
 Test Engineer : Alarak Wu
 Test Date : 2022-05-27

Air Discharge:

Test Voltage	Location	Actual criterion	Required performance criterion	Result (Pass/Fail)
±2; 4; 8 kV	Non-Conducted Enclosure	A	B	Pass
±2; 4; 8 kV	/	/	B	/
±2; 4; 8 kV	/	/	B	/

Contact Discharge

Test Voltage	Location	Actual criterion	Required performance criterion	Result (Pass/Fail)
±2; 4kV	Conducted Enclosure	A	B	Pass
±2; 4kV	Screw	A	B	Pass
±2; 4kV	All slots of the EUT	A	B	Pass

Indirect Discharge

Test Voltage	Location	Actual criterion	Required performance criterion	Result (Pass/Fail)
±2; 4 kV	HCP	A	B	Pass
±2; 4kV	VCP	A	B	Pass

12. CONTINUOUS RF ELECTROMAGNETIC FIELD DISTURBANCES

12.1. Test Specification

Test standard	: EN 55035	
Basic standard	: IEC 61000-4-3	
Performance criterion	: A	
Frequency range &	: <input checked="" type="checkbox"/> 80M-1000MHz	3V/m
Test level	: <input checked="" type="checkbox"/> Spot frequency	3V/m
	: <input type="checkbox"/> Additional spot frequency	3V/m
Modulation	: AM, 80%, 1kHz sine-wave	

12.2. Block Diagram of Test Setup

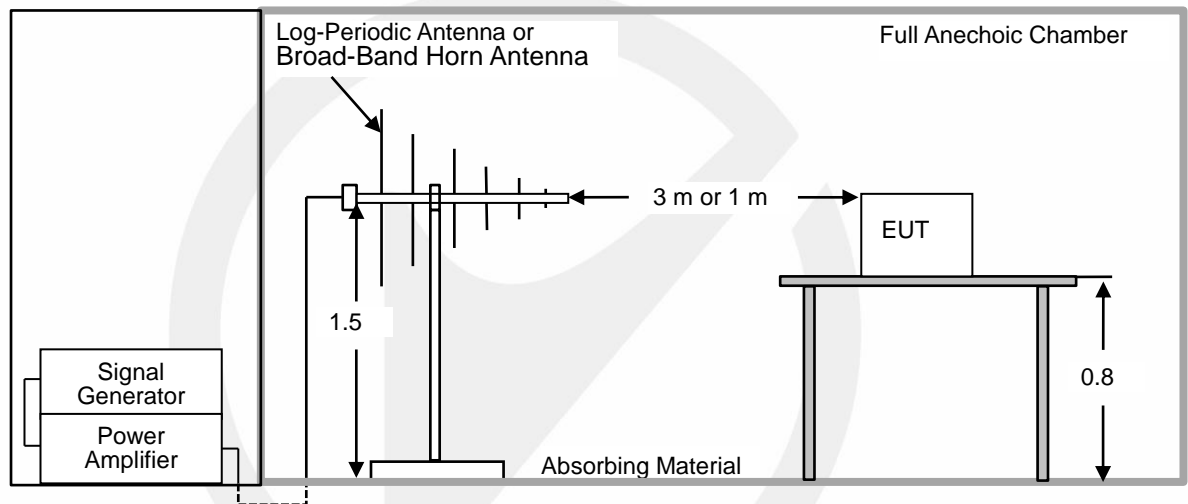

12.3. Test procedure

The procedure defined in this part requires the generation of electromagnetic fields within which the test sample is placed and its operation observed. To generate fields that are useful for simulation of actual (field) conditions may require significant antenna drive power and the resultant high field strength levels. To comply with local regulations and to prevent biological hazards to the testing personnel, it is recommended that these tests be carried out in a shielded enclosure or semi-anechoic chamber.

- a. The antenna which is enabling the complete frequency range of 80-1000 MHz is placed 3m (or 1m) away from the equipment. The required field strength is determined by placing the field strength meter(s) on top of or directly alongside the equipment under test and monitoring the field strength meter via a remote field strength indicator outside the enclosure while adjusting the continuous-wave to the antenna.
- b. The test is performed with the antenna facing the front and back sides of the EUT with. Both vertical and horizontal polarizations from antenna are tested.

12.4. Test results

Pass.

(The test was carried out at: EMTEK (SHENZHEN) CO., LTD)

Model DataHub1000 with adapter 1 (ABT020120A)

Temperature : 21°C
 Humidity : 48 %
 Atmospheric Pressure : 101kpa
 Test Engineer : CSL
 Test Date : 2021-12-03

80M-1000MHz:

Freq. Range (MHz)	Field	Modulation	Polarity	Position (°)	Actual criterion	Required performance criterion	Result
80-1000	3V/m	AM, 80%	H / V	0, 90,180, 270	A	A	Pass

Spot frequency:

Freq (MHz)	Field	Modulation	Polarity	Position (°)	Actual criterion	Required performance criterion	Result
1800, 2600, 3500, 5000	3V/m	AM, 80%	H / V	0, 90,180, 270	A	A	Pass

Additional spot frequency:

Freq (MHz)	Field	Modulation	Polarity	Position (°)	Actual criterion	Required performance criterion	Result
80, 120, 160, 230, 434, 460, 600, 863, 900	3V/m	AM, 80%	H / V	0, 90,180, 270	N/A	A	N/A

Model DataHub1000 with adapter 2 (BSG025W-1202000A)

Temperature : 25°C
 Humidity : 56 %
 Atmospheric Pressure : 101kpa
 Test Engineer : CSL
 Test Date : 2022-05-30

80M-1000MHz:

Freq. Range (MHz)	Field	Modulation	Polarity	Position (°)	Actual criterion	Required performance criterion	Result
80-1000	3V/m	AM, 80%	H / V	0, 90,180, 270	A	A	Pass

Spot frequency:

Freq (MHz)	Field	Modulation	Polarity	Position (°)	Actual criterion	Required performance criterion	Result
1800, 2600, 3500, 5000	3V/m	AM, 80%	H / V	0, 90,180, 270	A	A	Pass

Additional spot frequency:

Freq (MHz)	Field	Modulation	Polarity	Position (°)	Actual criterion	Required performance criterion	Result
80, 120, 160, 230, 434, 460, 600, 863, 900	3V/m	AM, 80%	H / V	0, 90,180, 270	N/A	A	N/A

13. ELECTRICAL FAST TRANSIENTS/BURST

13.1. Test Specification

- Test standard : EN 55035
- Basic standard : IEC 61000-4-4
- Performance criterion : B
- Test level : 1kV, AC mains power ports
 0.5kV, DC network power ports
 0.5kV, Analogue/digital data ports
- Repetition frequency : 5kHz, 100kHz(Only xDSL ports)
- Tr/Th: : 5/50ns
- Burst period : 300ms
- Test time : : 120s

13.2. Block Diagram of Test Setup

AC Lines:

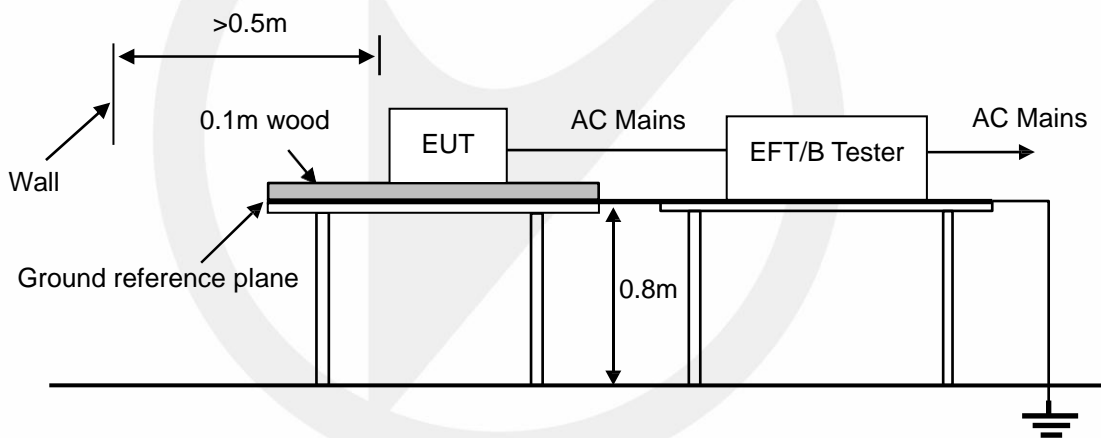

Signal lines:

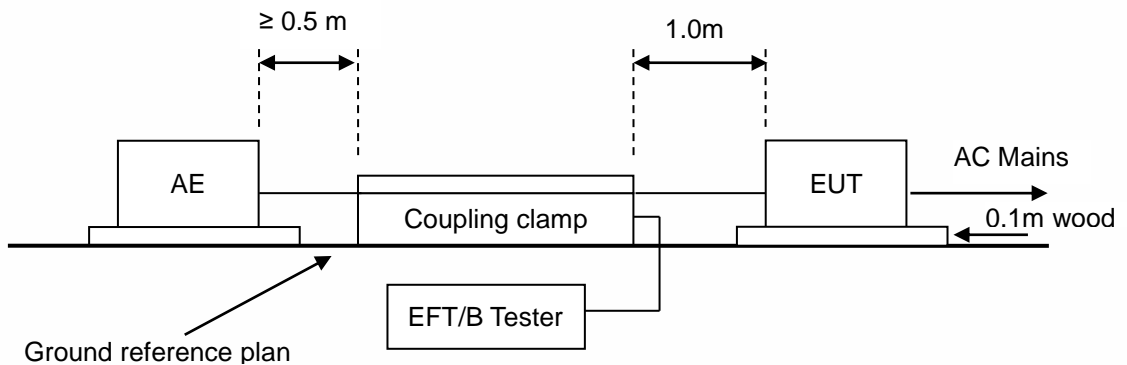

13.3. Test Procedure

The EUT is put on the table that is 0.8 meter high above the ground. This reference ground plane shall project beyond the EUT by at least 0.1m on all sides and the minimum distance between EUT and all other conductive structure, except the ground plane beneath the EUT, shall be more than 0.5m.

13.4. Test Results

Pass.

Model DataHub1000 with adapter 1 (ABT020120A)

Temperature : 25 °C
 Humidity : 49 %
 Atmospheric Pressure : 101kpa
 Test Engineer : LSL
 Test Date : 2021-12-01

Injection Line	Voltage (kV)	Injected Method	Actual criterion	Required performance criterion	Result (Pass/Fail)
<input checked="" type="checkbox"/> AC mains power ports	± 1	<input type="checkbox"/> CDN <input checked="" type="checkbox"/> Direct injection <input type="checkbox"/> Capacitive coupling clamp	A	B	Pass
<input type="checkbox"/> DC network power ports	± 0.5	<input type="checkbox"/> CDN <input type="checkbox"/> Direct injection <input type="checkbox"/> Capacitive coupling clamp	N/A	B	N/A
<input checked="" type="checkbox"/> Analogue/digital data ports (Wired network port)	± 0.5	<input type="checkbox"/> CDN <input type="checkbox"/> Direct injection <input checked="" type="checkbox"/> Capacitive coupling clamp	A	B	Pass
<input type="checkbox"/> Analogue/digital data ports (Broadcast receiver tuner port)	± 0.5	<input type="checkbox"/> CDN <input type="checkbox"/> Direct injection <input type="checkbox"/> Capacitive coupling clamp	N/A	B	N/A
<input type="checkbox"/> Analogue/digital data ports (.....)	± 0.5	<input type="checkbox"/> CDN <input type="checkbox"/> Direct injection <input type="checkbox"/> Capacitive coupling clamp	N/A	B	N/A

Model DataHub1000 with with adapter 2 (BSG025W-1202000A)

Temperature : 25 °C
 Humidity : 62 %
 Atmospheric Pressure : 101kpa
 Test Engineer : Alarak Wu
 Test Date : 2022-05-27

Injection Line	Voltage (kV)	Injected Method	Actual criterion	Required performance criterion	Result (Pass/Fail)
<input checked="" type="checkbox"/> AC mains power ports	± 1	<input type="checkbox"/> CDN <input checked="" type="checkbox"/> Direct injection <input type="checkbox"/> Capacitive coupling clamp	A	B	Pass
<input type="checkbox"/> DC network power ports	± 0.5	<input type="checkbox"/> CDN <input type="checkbox"/> Direct injection <input type="checkbox"/> Capacitive coupling clamp	N/A	B	N/A
<input checked="" type="checkbox"/> Analogue/digital data ports (Wired network port)	± 0.5	<input type="checkbox"/> CDN <input type="checkbox"/> Direct injection <input checked="" type="checkbox"/> Capacitive coupling clamp	A	B	Pass
<input type="checkbox"/> Analogue/digital data ports (Broadcast receiver tuner port)	± 0.5	<input type="checkbox"/> CDN <input type="checkbox"/> Direct injection <input type="checkbox"/> Capacitive coupling clamp	N/A	B	N/A
<input type="checkbox"/> Analogue/digital data ports (.....)	± 0.5	<input type="checkbox"/> CDN <input type="checkbox"/> Direct injection <input type="checkbox"/> Capacitive coupling clamp	N/A	B	N/A

14. SURGES

14.1. Test Specification

Test standard	:	EN 55035
Basic standard	:	IEC 61000-4-5
Test level	:	<input checked="" type="checkbox"/> 1kV, Line to Line, AC mains power ports, Criterion B <input type="checkbox"/> 2kV, Line to Earth, AC mains power ports, Criterion B <input type="checkbox"/> 0.5kV, Line to Reference ground, DC network power ports, Criterion B <input type="checkbox"/> 1.0kV, 4.0kV, Lines to Ground, Unshielded symmetrical, where primary protection is intended, Criterion C <input checked="" type="checkbox"/> 1.0kV, Lines to Ground, Unshielded symmetrical, where primary protection is not intended Criterion C <input type="checkbox"/> 0.5kV, Shield to ground, Coaxial or shielded port, Criterion B
Number of surges	:	5 (for each combination of parameters)
Repetition rate	:	1 minute / time
Polarity:	:	Positive / Negative
Phase angle:	:	90°, 270° (Only AC mains power ports)

14.2. Block Diagram of Test Setup

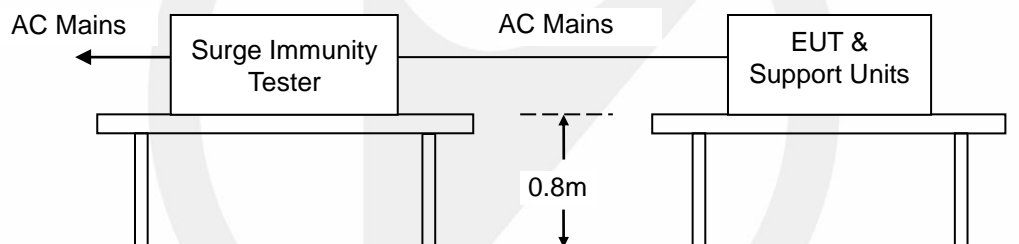

14.3. Test Procedure

This test simulates a lightning event by inducing transients onto the AC/DC power supply lines in common mode (Line to Ground) and differential mode (Line to Line). Each device was tested in a total of two surge configurations: Line to Ground (L-G): Combination Wave, Line to Protective Earth with 9uF and 10Ohm and Neutral to Protective Earth with 9uF and 10Ohm, common mode, generator earthed.

Line to Line (L-L): Combination Wave,

Line to Neutral with 18uF, differential mode, generator floated.

2 ohm : the source impedance of the low-voltage power supply network.

12 ohm : the source impedance of the low-voltage power supply network and ground.

- If not otherwise specified the surges have to be applied synchronized to the voltage phase at the zero-crossing and the peak value of the a.c. voltage wave (positive and negative).
- The surges have to be applied line to line and line to earth. When testing line to earth, the test voltage has to be applied successively between each of the lines and earth, if there is no other specification.
- The test procedure shall also consider the non-linear current-voltage characteristics of the equipment under test. Therefore the test voltage has to be increased by steps up to the test level specified in the product standard or test plan. All lower levels including the selected test level shall be satisfied.
- For testing the secondary protection, the output voltage of the generator shall be increased up to the worst-case voltage breakdown level (let-through level) of the primary protection.
- Testing shall be performed according to a Test Plan, which shall be included in the test report.
- To find all critical points of the duty cycle of the equipment, a sufficient number of positive and negative test pulses shall be applied.

14.4. Test results

Pass.

Model DataHub1000 with adapter 1 (ABT020120A)

Temperature : 25 °C
 Humidity : 49 %
 Atmospheric Pressure : 101kpa
 Test Engineer : LSL
 Test Date : 2021-12-01

AC mains power ports:

Coupling Line	Voltage (kV)	Waveform (µs)	Polarity	Actual criterion	Required performance criterion	Result (Pass/Fail)
<input checked="" type="checkbox"/> Line to line	1	1.2/50 (8/20)	Pos./ Neg.	A	B	Pass
<input type="checkbox"/> Line to earth	2	1.2/50 (8/20)	Pos./ Neg.	N/A	B	N/A

DC network power ports:

Coupling Line	Voltage (kV)	Waveform (µs)	Polarity	Actual criterion	Required performance criterion	Result (Pass/Fail)
Line to Reference ground	0.5	1.2/50 (8/20)	Pos./ Neg.	N/A	B	N/A

Analogue/digital data ports:

Port type	Coupling Line	Voltage (kV)	Waveform (µs)	Polarity	Actual criterion	Required performance criterion	Result (Pass/Fail)
<input checked="" type="checkbox"/> Unshielded symmetrical (Wired network port)	Lines to ground	0.5, 1	10/700 (5/320)	Pos./ Neg.	A	C	Pass
<input type="checkbox"/> Unshielded symmetrical (.....)	Lines to ground	0.5, 1	10/700 (5/320)	Pos./ Neg.	N/A	C	N/A
<input type="checkbox"/> Unshielded symmetrical	Lines to ground	0.5, 1, 2, 4	10/700 (5/320)	Pos./ Neg.	N/A	C	N/A
<input type="checkbox"/> Coaxial or shielded (Broadcast receiver tuner port)	Shield to ground	0.5	1.2/50 (8/20)	Pos./ Neg.	N/A	B	N/A
<input type="checkbox"/> Coaxial or shielded (.....)	Shield to ground	0.5	1.2/50 (8/20)	Pos./ Neg.	N/A	B	N/A

Model DataHub1000 with with adapter 2 (BSG025W-1202000A)

Temperature : 25 °C
 Humidity : 62 %
 Atmospheric Pressure : 101kpa
 Test Engineer : Alarak Wu
 Test Date : 2022-05-27

 AC mains power ports:

Coupling Line	Voltage (kV)	Waveform (μs)	Polarity	Actual criterion	Required performance criterion	Result (Pass/Fail)
<input checked="" type="checkbox"/> Line to line	1	1.2/50 (8/20)	Pos./ Neg.	A	B	Pass
<input type="checkbox"/> Line to earth	2	1.2/50 (8/20)	Pos./ Neg.	N/A	B	N/A

 DC network power ports:

Coupling Line	Voltage (kV)	Waveform (μs)	Polarity	Actual criterion	Required performance criterion	Result (Pass/Fail)
Line to Reference ground	0.5	1.2/50 (8/20)	Pos./ Neg.	N/A	B	N/A

 Analogue/digital data ports:

Port type	Coupling Line	Voltage (kV)	Waveform (μs)	Polarity	Actual criterion	Required performance criterion	Result (Pass/Fail)
<input checked="" type="checkbox"/> Unshielded symmetrical (Wired network port)	Lines to ground	0.5, 1	10/700 (5/320)	Pos./ Neg.	A	C	Pass
<input type="checkbox"/> Unshielded symmetrical (.....)	Lines to ground	0.5, 1	10/700 (5/320)	Pos./ Neg.	N/A	C	N/A
<input type="checkbox"/> Unshielded symmetrical	Lines to ground	0.5, 1, 2, 4	10/700 (5/320)	Pos./ Neg.	N/A	C	N/A
<input type="checkbox"/> Coaxial or shielded (Broadcast receiver tuner port)	Shield to ground	0.5	1.2/50 (8/20)	Pos./ Neg.	N/A	B	N/A
<input type="checkbox"/> Coaxial or shielded (.....)	Shield to ground	0.5	1.2/50 (8/20)	Pos./ Neg.	N/A	B	N/A

15. CONTINUOUS INDUCED RF DISTURBANCES

15.1. Test Specification

Test standard	: EN 55035
Basic standard	: IEC 61000-4-6
Performance criterion	: A
Frequency range & Test level	: 0.15M to 10MHz, 3V 10M to 30MHz, 3V to 1V 30M to 80MHz, 1V
Modulation	: AM 80%, 1kHz sine-wave
Frequency Step	: 1% of fundamental

15.2. Block Diagram of Test Setup

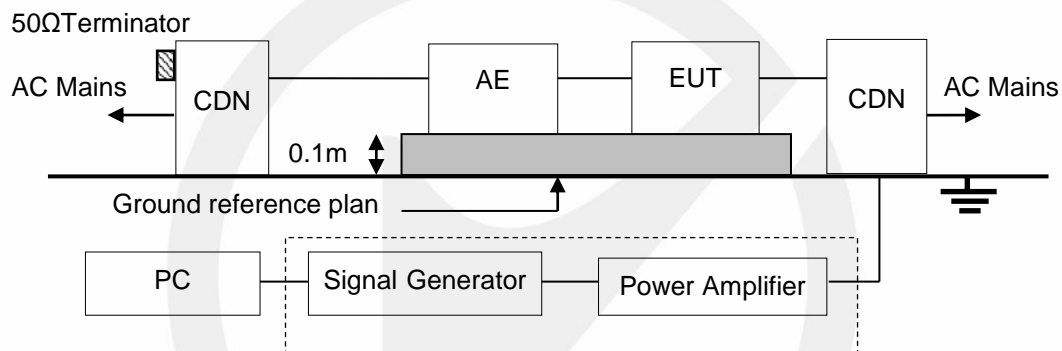

15.3. Test Procedure

- The EUT shall be operated within its intended climatic conditions. The temperature and relative humidity should be recorded.
- The EUT is placed on a 0.1m high test table, and a well grounded cable is connected to metallic plane above the test table.
- All cables/wires must be laid out on test plate (3cm in thickness), and the EUT is set up on test plate (10 cm in thickness) as shown in test setup photo, and the cables/wires must not be in mid-air, they should be touching the surface of test plate. Ensure that the EUT is properly connected to the accessory equipment.
- The test shall be performed with the test generator connected to each of the coupling and decoupling devices in turn while the other non-excited RF-input ports of the coupling devices are terminated by a 50 ohm load resistor.
- The frequency range is swept from 150 kHz to 80 MHz, using the signal levels established during the setting process, and with the disturbance signal 80% amplitude modulated with a 1 kHz sine wave, pausing to adjust the RF-signal level or to switch coupling devices as necessary. The rate of sweep shall no exceed 1.5×10^{-3} decades/s. Where the frequency is swept incrementally, the step size shall no exceed 1% of the start and thereafter 1% of the preceding frequency value.
- The dwell time at each frequency shall not be less than the time necessary for the EUT to be exercised, and able to respond. Sensitive frequencies e.g. clock frequency (ies) and harmonics or frequencies of dominant interest shall be analyzed separately.
- Attempts should be made to fully exercise the EUT during testing, and to fully interrogate all exercise modes selected for susceptibility
- Testing shall be performed according to a Test Plan, which shall be included in the test report.

15.4. Test results

Pass.

Model DataHub1000 with adapter 1 (ABT020120A)

Temperature : 25 °C
 Humidity : 49 %
 Atmospheric Pressure : 101kpa
 Test Engineer : LSL
 Test Date : 2021-12-01

Range (MHz)	Levers (V)	Injection port	Coupling type	Actual criterion	Required performance criterion	Result (Pass/Fail)
0.15-10	3	<input checked="" type="checkbox"/> AC mains power ports	<input checked="" type="checkbox"/> CDN <input type="checkbox"/> EM Clamp <input type="checkbox"/> Current Clamp <input type="checkbox"/> Direct injection	A	A	Pass
10-30	3-1					
30-80	1					
0.15-10	3	<input type="checkbox"/> DC network power ports	<input type="checkbox"/> CDN <input type="checkbox"/> EM Clamp <input type="checkbox"/> Current Clamp <input type="checkbox"/> Direct injection	N/A	A	N/A
10-30	3-1					
30-80	1					
0.15-10	3	<input checked="" type="checkbox"/> Analogue/digital data ports (Wired network port)	<input type="checkbox"/> CDN <input type="checkbox"/> EM Clamp <input checked="" type="checkbox"/> Current Clamp <input type="checkbox"/> Direct injection	A	A	Pass
10-30	3-1					
30-80	1					
0.15-10	3	<input type="checkbox"/> Analogue/digital data ports (Broadcast receiver tuner port)	<input type="checkbox"/> CDN <input type="checkbox"/> EM Clamp <input type="checkbox"/> Current Clamp <input type="checkbox"/> Direct injection	N/A	A	N/A
10-30	3-1					
30-80	1					
0.15-10	3	<input type="checkbox"/> Analogue/digital data ports (.....)	<input type="checkbox"/> CDN <input type="checkbox"/> EM Clamp <input type="checkbox"/> Current Clamp <input type="checkbox"/> Direct injection	N/A	A	N/A
10-30	3-1					
30-80	1					

Model DataHub1000 with with adapter 2 (BSG025W-1202000A)

Temperature : 25 °C
 Humidity : 62 %
 Atmospheric Pressure : 101kpa
 Test Engineer : Alarak Wu
 Test Date : 2022-05-27

Range (MHz)	Levers (V)	Injection port	Coupling type	Actual criterion	Required performance criterion	Result (Pass/Fail)
0.15-10	3	<input checked="" type="checkbox"/> AC mains power ports	<input checked="" type="checkbox"/> CDN <input type="checkbox"/> EM Clamp <input type="checkbox"/> Current Clamp <input type="checkbox"/> Direct injection	A	A	Pass
10-30	3-1					
30-80	1					
0.15-10	3	<input type="checkbox"/> DC network power ports	<input type="checkbox"/> CDN <input type="checkbox"/> EM Clamp <input type="checkbox"/> Current Clamp <input type="checkbox"/> Direct injection	N/A	A	N/A
10-30	3-1					
30-80	1					
0.15-10	3	<input checked="" type="checkbox"/> Analogue/digital data ports (Wired network port)	<input type="checkbox"/> CDN <input type="checkbox"/> EM Clamp <input checked="" type="checkbox"/> Current Clamp <input type="checkbox"/> Direct injection	A	A	Pass
10-30	3-1					
30-80	1					
0.15-10	3	<input type="checkbox"/> Analogue/digital data ports (Broadcast receiver tuner port)	<input type="checkbox"/> CDN <input type="checkbox"/> EM Clamp <input type="checkbox"/> Current Clamp <input type="checkbox"/> Direct injection	N/A	A	N/A
10-30	3-1					
30-80	1					
0.15-10	3	<input type="checkbox"/> Analogue/digital data ports (.....)	<input type="checkbox"/> CDN <input type="checkbox"/> EM Clamp <input type="checkbox"/> Current Clamp <input type="checkbox"/> Direct injection	N/A	A	N/A
10-30	3-1					
30-80	1					

16. POWER FREQUENCY MAGNETIC FIELD

16.1. Test Specification

Test Standard : EN 55035
 Basic Standard : IEC 61000-4-8
 Performance criterion : A
 Test level : 1A/m

16.2. Block Diagram of Test Setup

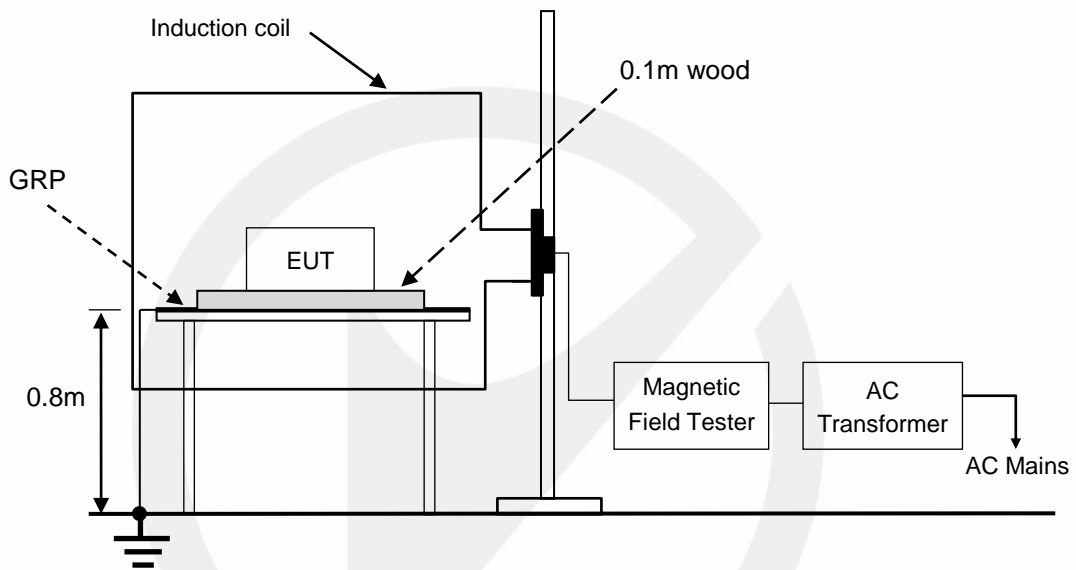

GRP: Ground reference plane
 EUT: Equipment under test

16.3. Test Procedure

The EUT is placed in the middle of a induction coil (1*1m), under which is a 1*1*0.1m (high) table above the GRP, this small table is also placed on a larger table, 0.8 m above the ground. Both horizontal and vertical polarization of the induction coil is set on test, so that each side of the EUT is affected by the magnetic field. Also can reach the same aim by change the position of the EUT.

16.4. Test Results

N/A.

17. VOLTAGE DIPS AND INTERRUPTIONS

17.1. Test Specification

Test standard	: EN 55035
Basic standard	: IEC 61000-4-11
Test level	: 0%, 0.5 period, Criterion B
	<input checked="" type="checkbox"/> 70%, 25 periods for 50Hz, Criterion C
	<input checked="" type="checkbox"/> 70%, 30 periods for 60Hz, Criterion C
	<input checked="" type="checkbox"/> 0%, 250 periods for 50Hz, Criterion C
	<input checked="" type="checkbox"/> 0%, 300 periods for 60Hz, Criterion C

17.2. Block Diagram of Test Setup

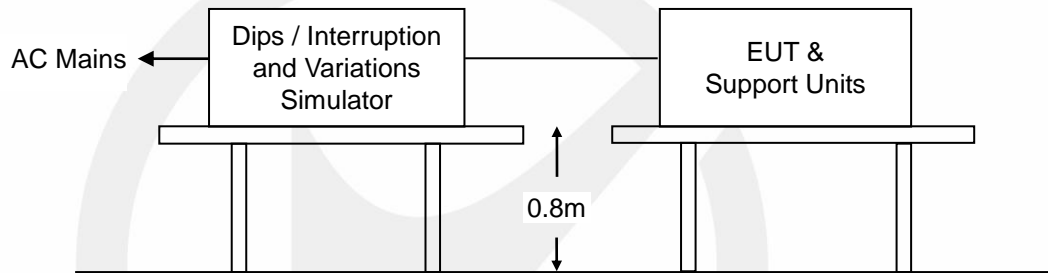

17.3. Test Procedure

- a. Where the equipment has a rated voltage the following shall apply - If the voltage range does not exceed 20% of the lower voltage specified for the rated voltage range, a single voltage within that range may be specified as a basis for test level specification.
 - In all other cases, the test procedure shall be applied for both the lowest and highest voltages declared in the voltage range.
- b. Test Conditions
 - Select operated voltage and frequency of EUT - Test of interval : 10 sec.
 - Level and duration : Sequence of 3 dips/interrupts.
 - Voltage rise (and fall) time : 1.5 μ s.

17.4. Test results

Pass.

Model DataHub1000 with adapter 1 (ABT020120A)

Temperature : 25 °C
 Humidity : 49 %
 Atmospheric Pressure : 101kpa
 Test Engineer : LSL
 Test Date : 2021-12-01

Item	Test Level (% UT)	Phase angle (°)	Input Voltage (V)	Freq (Hz)	Duration (periods)	Actual criterion	Required performance criterion	Result (Pass /Fail)
<input checked="" type="checkbox"/> Voltage dips	0%	0°, 180°	AC 230V	50	0.5	A	B	Pass
<input checked="" type="checkbox"/> Voltage dips	0%	0°, 180°	AC 230V	60	0.5	A	B	Pass
<input checked="" type="checkbox"/> Voltage dips	70%	0°, 180°	AC 230V	50	25	A	C	Pass
<input checked="" type="checkbox"/> Voltage dips	70%	0°, 180°	AC 230V	60	30	A	C	Pass
<input checked="" type="checkbox"/> Voltage interruptions	0%	0°, 180°	AC 230V	50	250	B	C	Pass
<input checked="" type="checkbox"/> Voltage interruptions	0%	0°, 180°	AC 230V	60	300	B	C	Pass

Model DataHub1000 with with adapter 2 (BSG025W-1202000A)

Temperature : 25 °C
 Humidity : 62 %
 Atmospheric Pressure : 101kpa
 Test Engineer : Alarak Wu
 Test Date : 2022-05-27

Item	Test Level (% UT)	Phase angle (°)	Input Voltage (V)	Freq (Hz)	Duration (periods)	Actual criterion	Required performance criterion	Result (Pass /Fail)
<input checked="" type="checkbox"/> Voltage dips	0%	0°, 180°	AC 230V	50	0.5	A	B	Pass
<input checked="" type="checkbox"/> Voltage dips	0%	0°, 180°	AC 230V	60	0.5	A	B	Pass
<input checked="" type="checkbox"/> Voltage dips	70%	0°, 180°	AC 230V	50	25	A	C	Pass
<input checked="" type="checkbox"/> Voltage dips	70%	0°, 180°	AC 230V	60	30	A	C	Pass
<input checked="" type="checkbox"/> Voltage interruptions	0%	0°, 180°	AC 230V	50	250	A	C	Pass
<input checked="" type="checkbox"/> Voltage interruptions	0%	0°, 180°	AC 230V	60	300	A	C	Pass

18. PHOTOGRAPHS

18.1. Photo of Conducted Emission Measurement

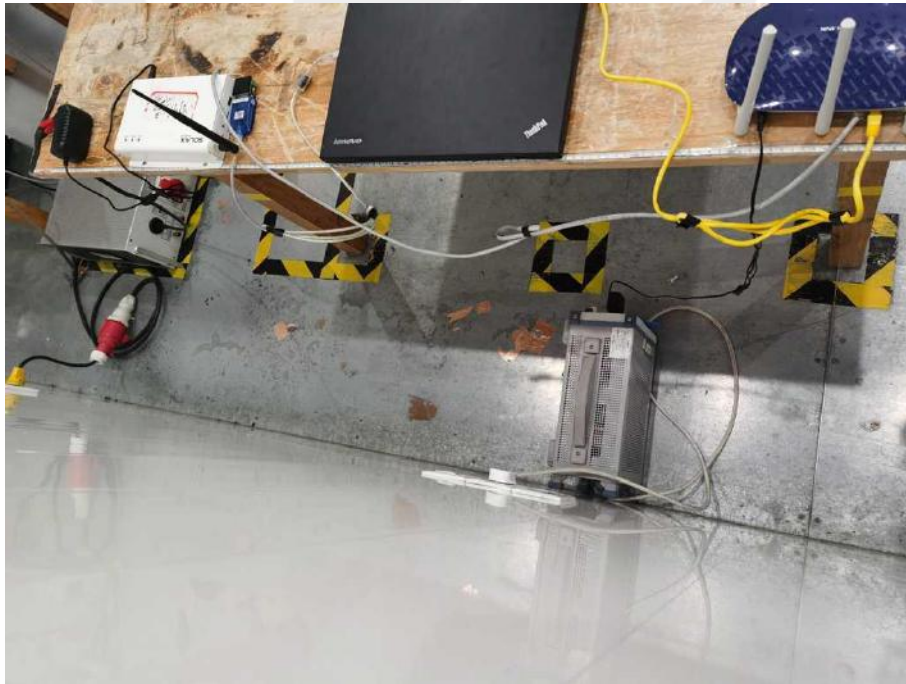

18.2. Photo of Conducted Emissions at Telecommunications/network port Measurement



18.3.Photo of Radiation Emission Measurement (Up to 1GHz)

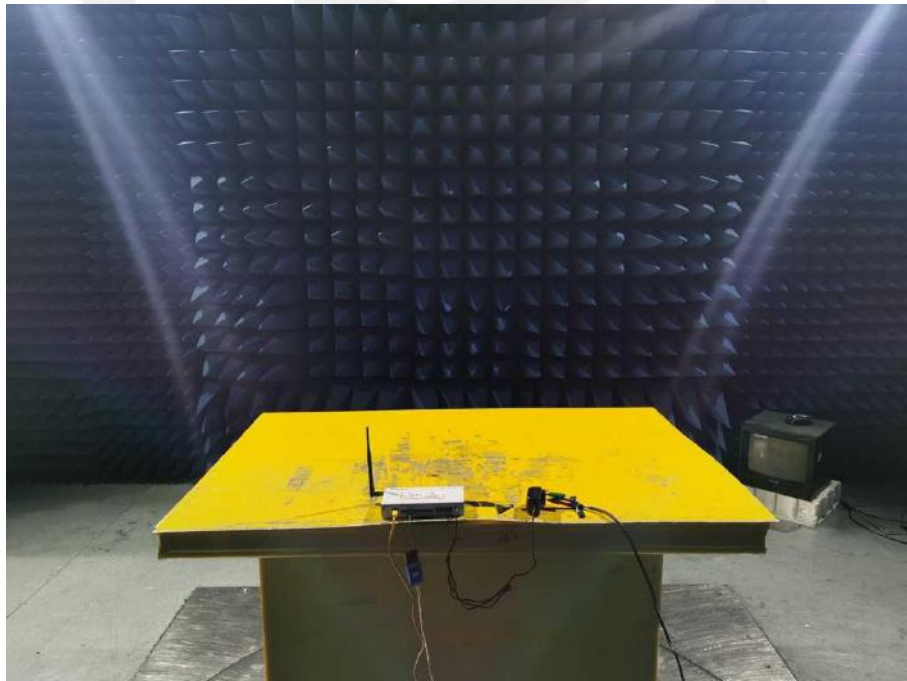

18.4.Photo of Radiation Emission Measurement (Above 1GHz)

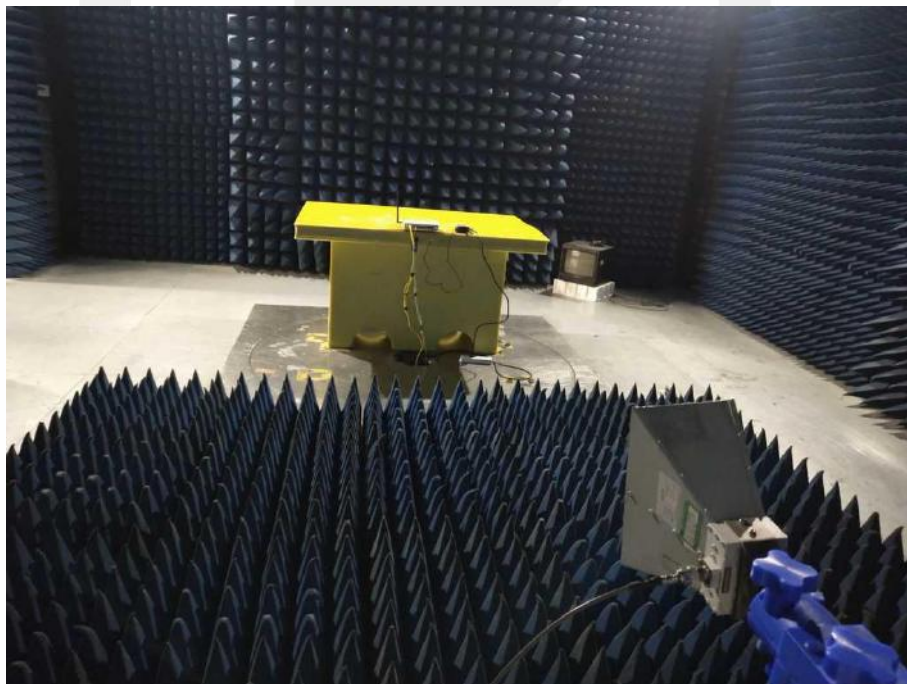
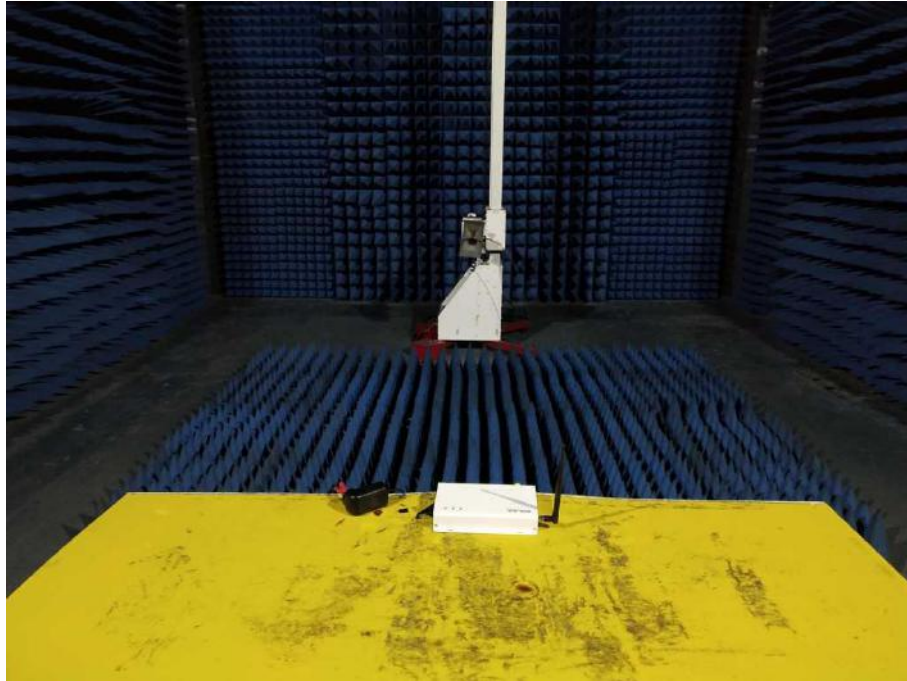

18.5.Photo of Harmonic and Flicker Measurement

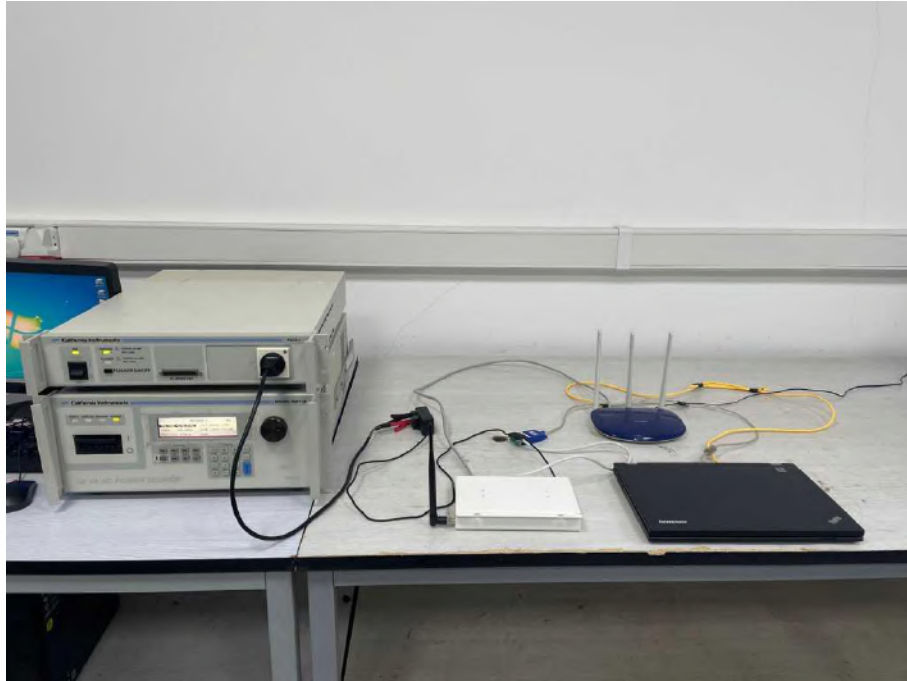

18.6.Photo of Electrostatic Discharge Test

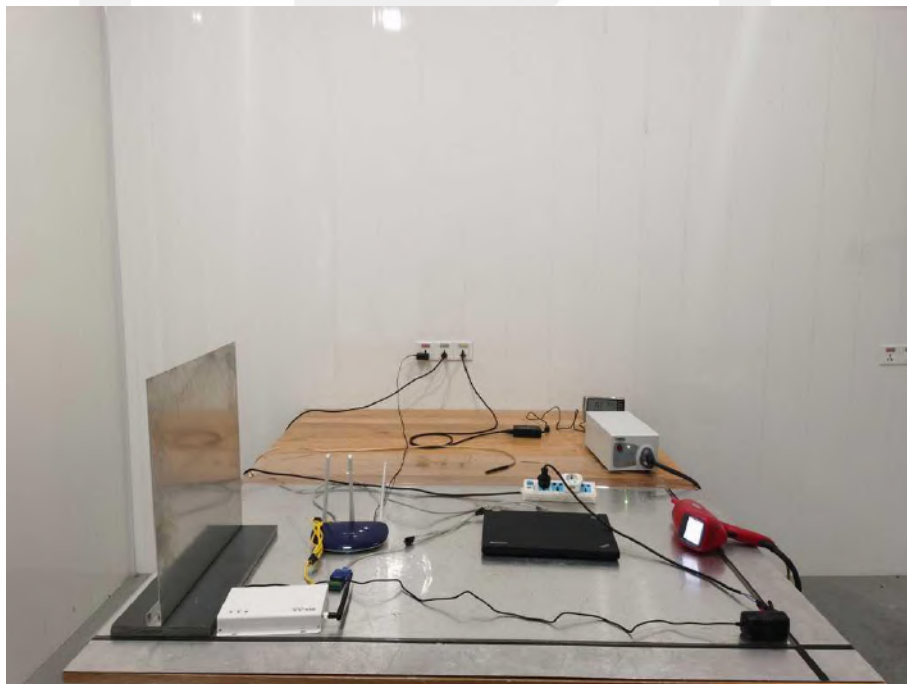

18.7. Photo of RF Field Strength Susceptibility Test

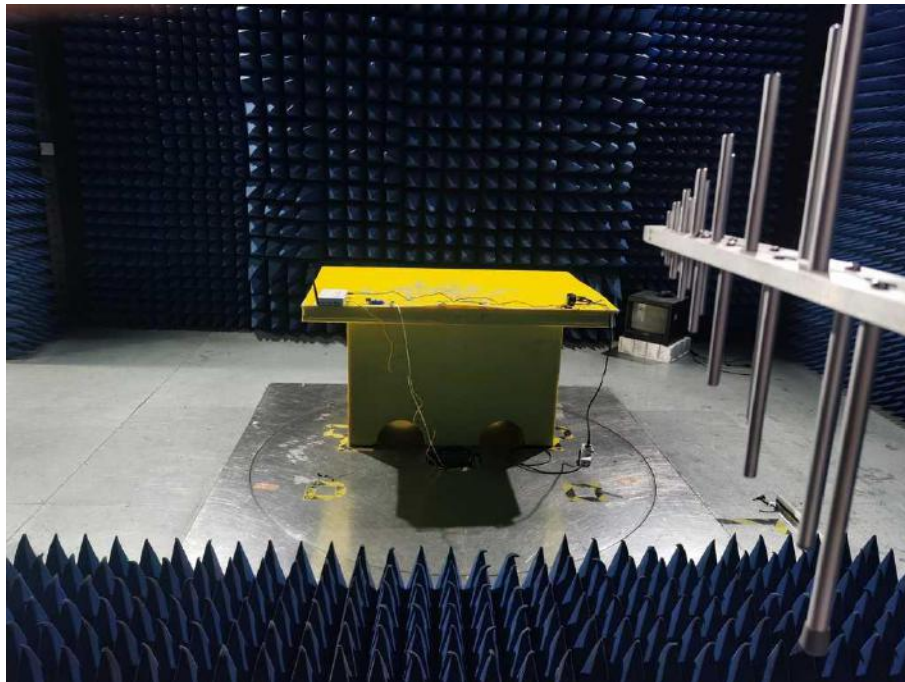

18.8. Photo of Electrical Fast Transient /Burst Test

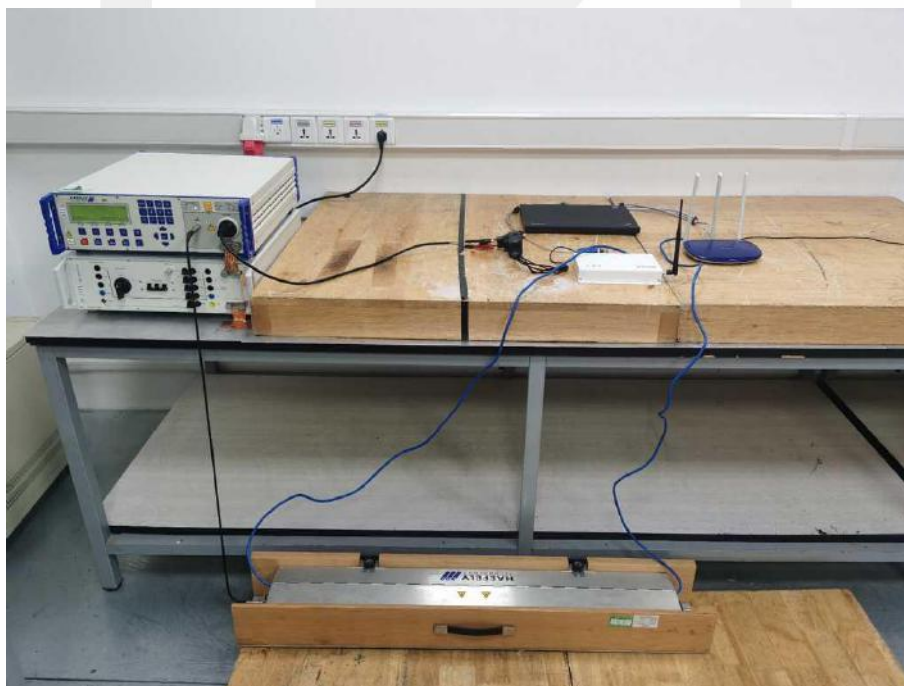

18.9.Photo of Surge Test



18.10.Photo of Injected Currents Susceptibility Test



18.11.Photo of Voltage Dips and Interruption Immunity Test

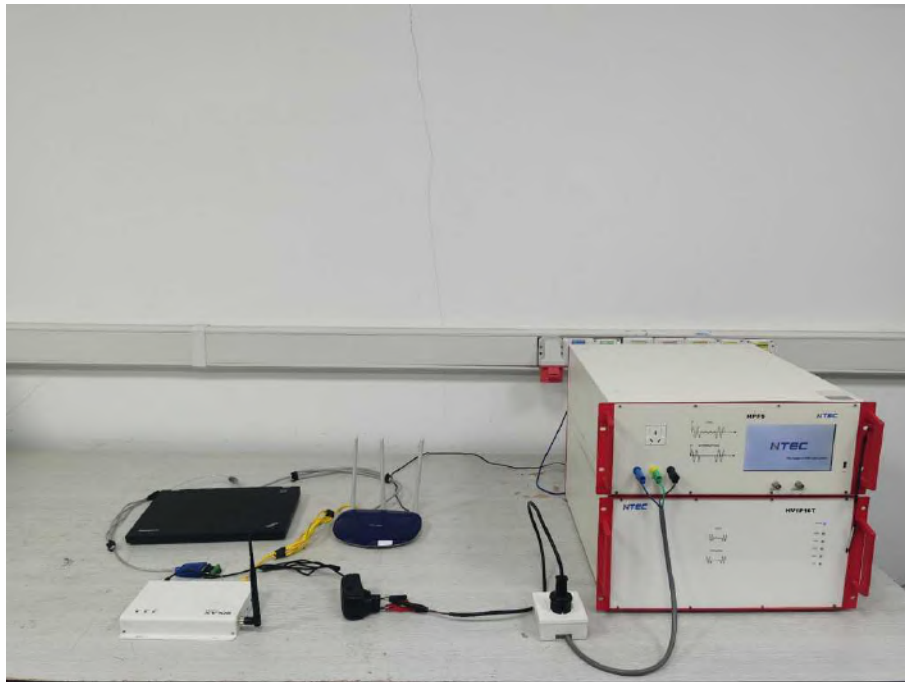



**APPENDIX
(PHOTOS OF EUT)**

Model DataHub1000 with adapter 1 (ABT020120A)

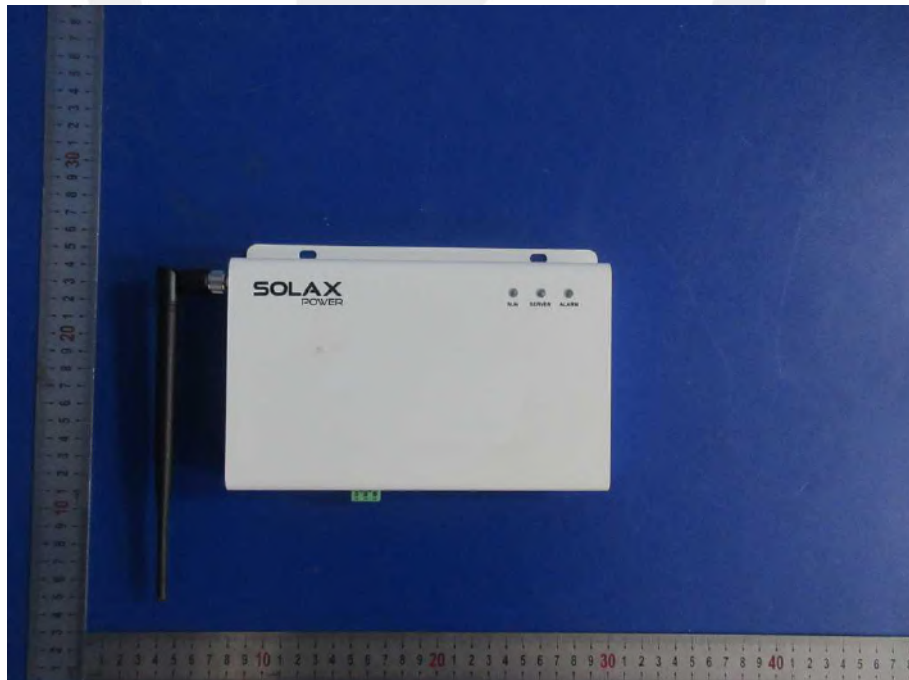
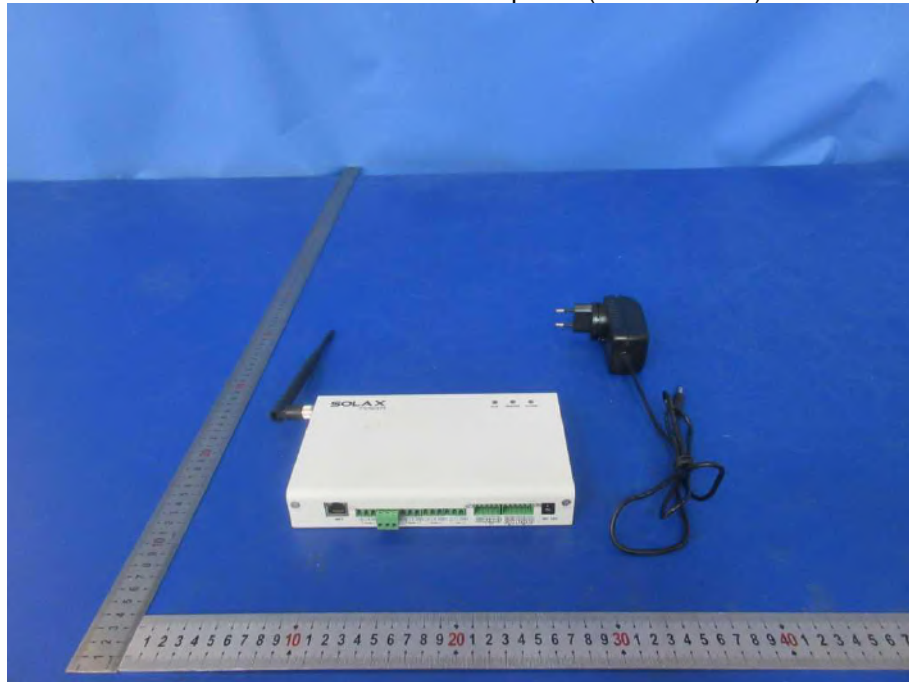

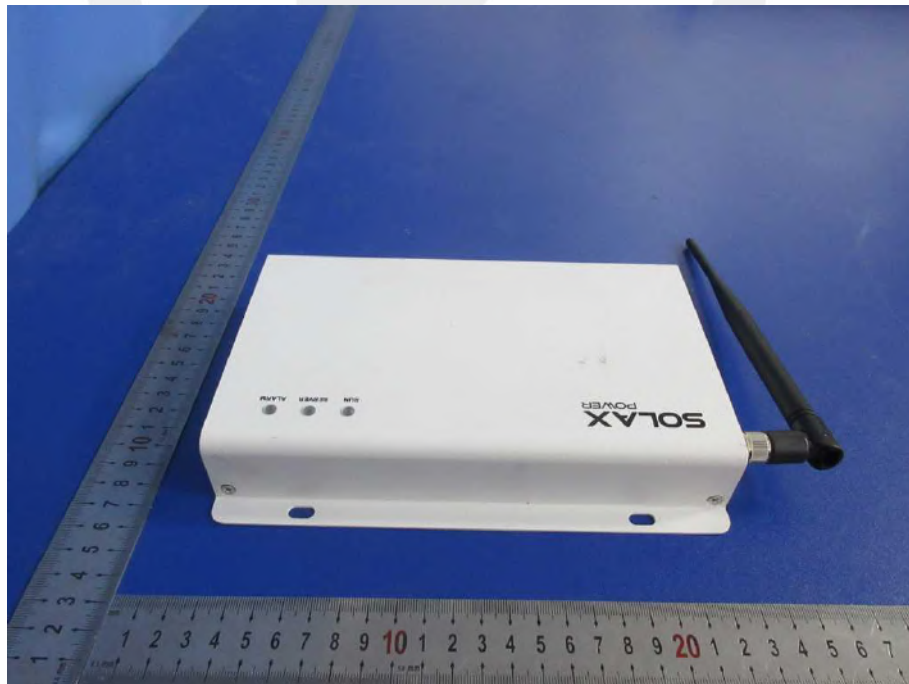

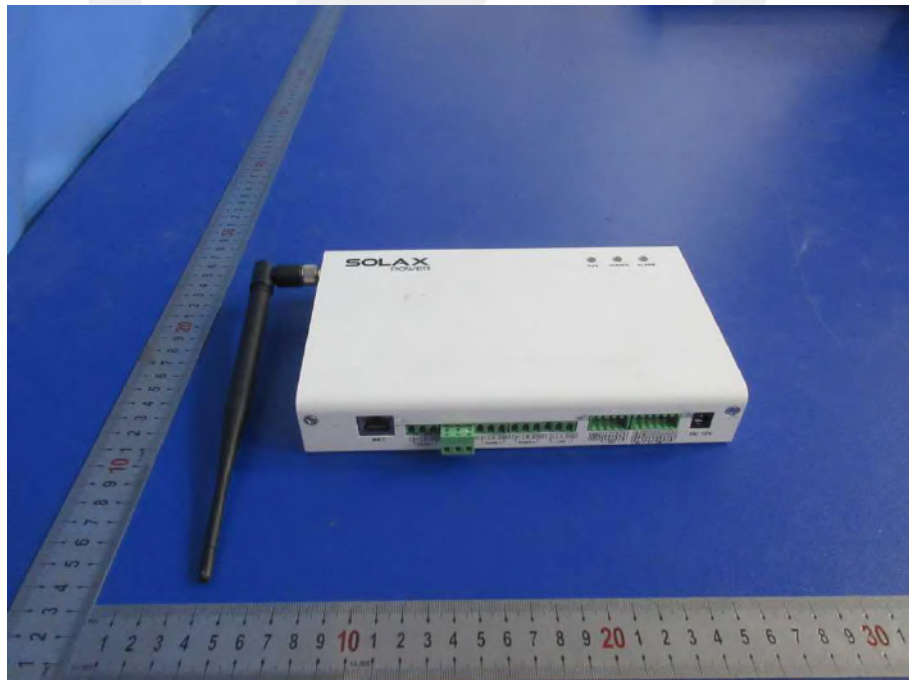

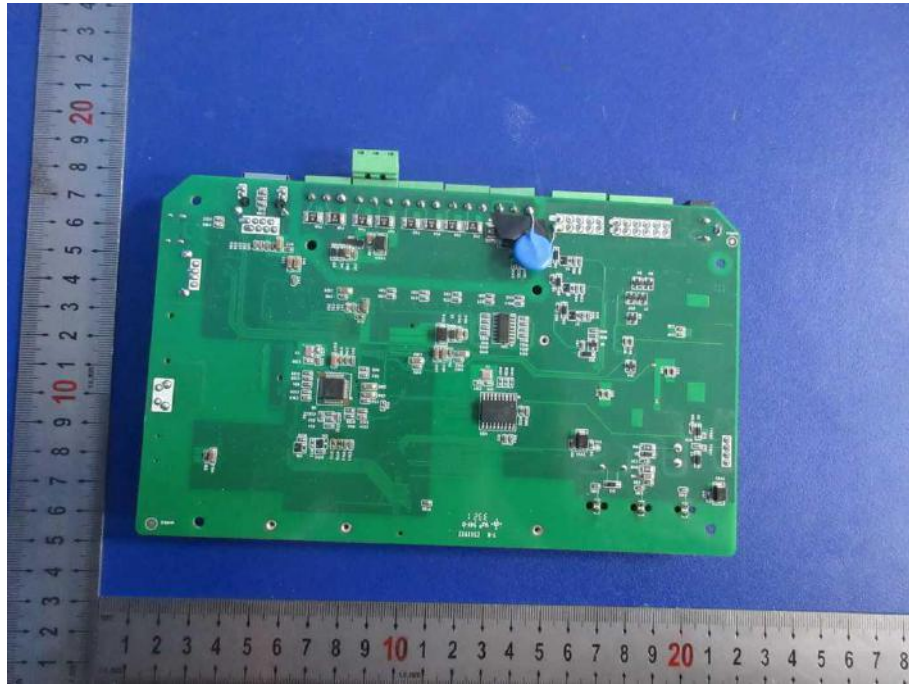

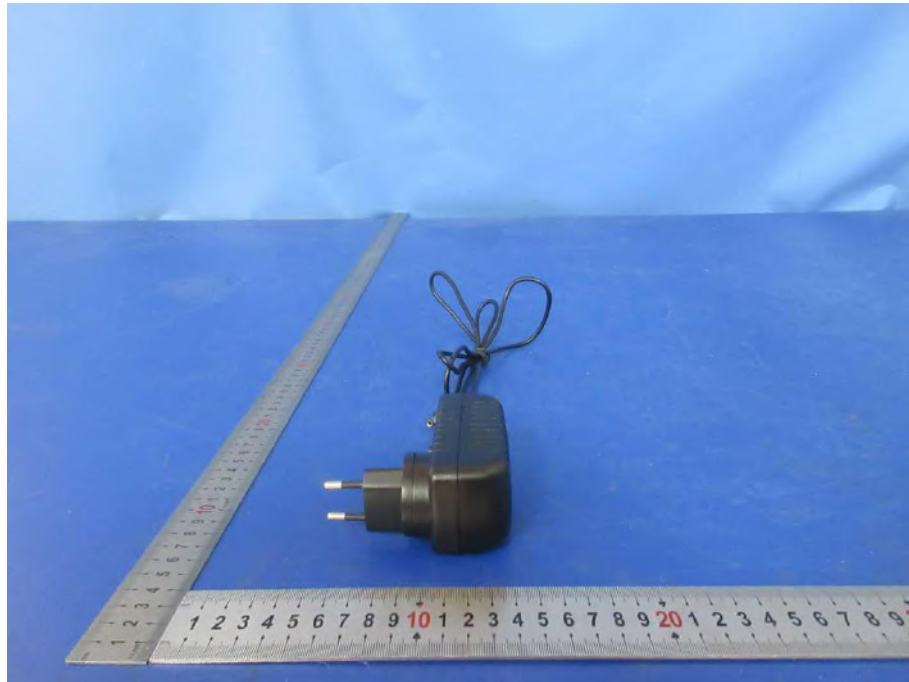

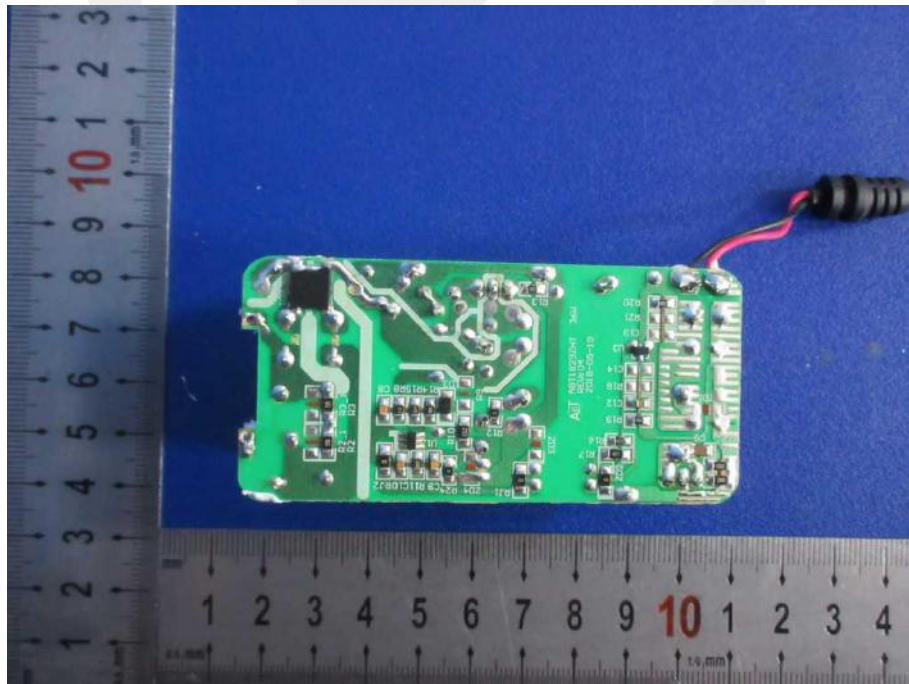



Model DataHub1000 with adapter 2





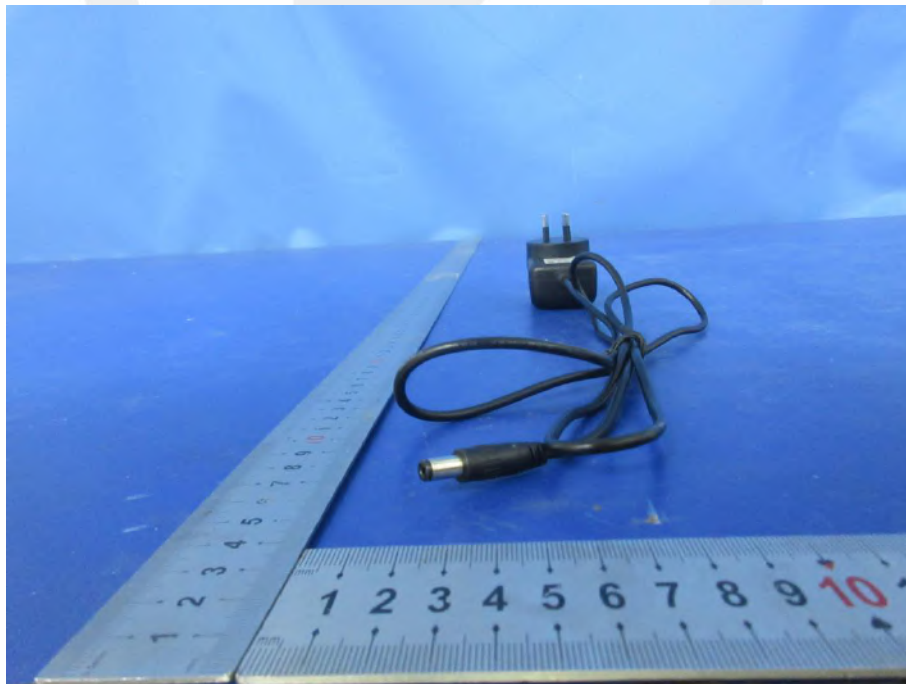
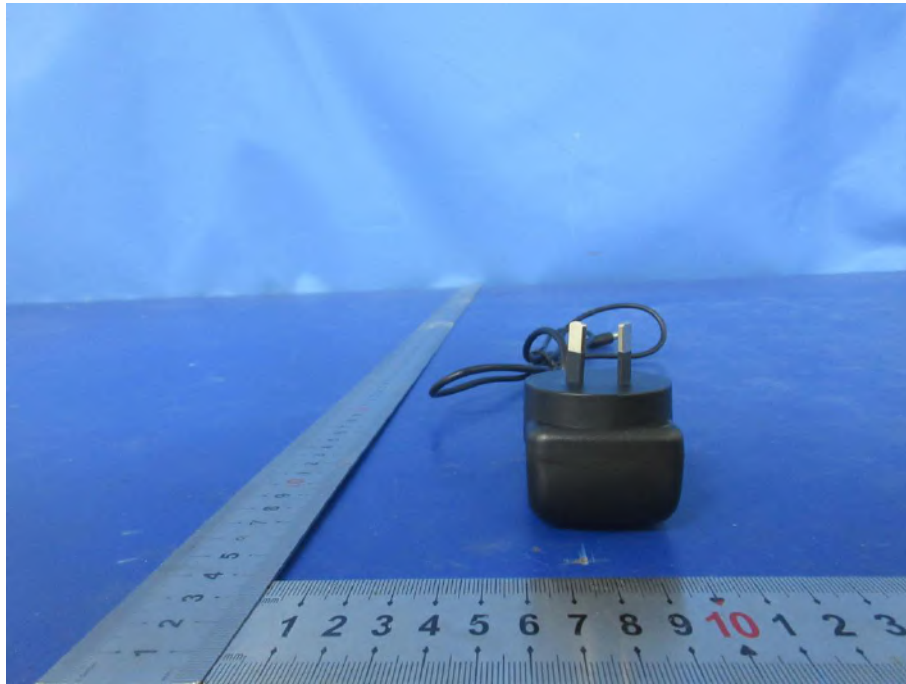

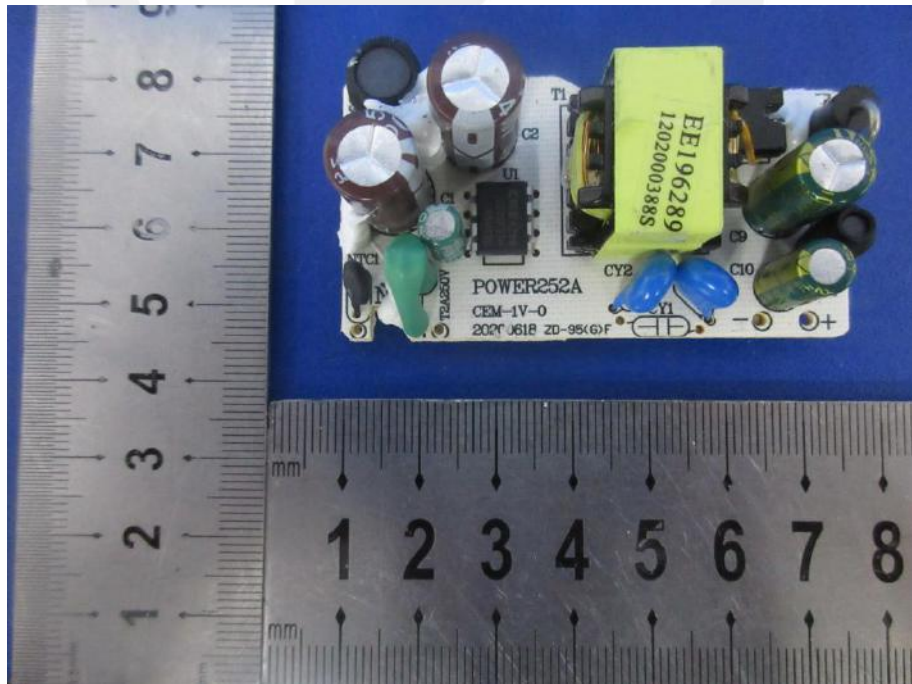

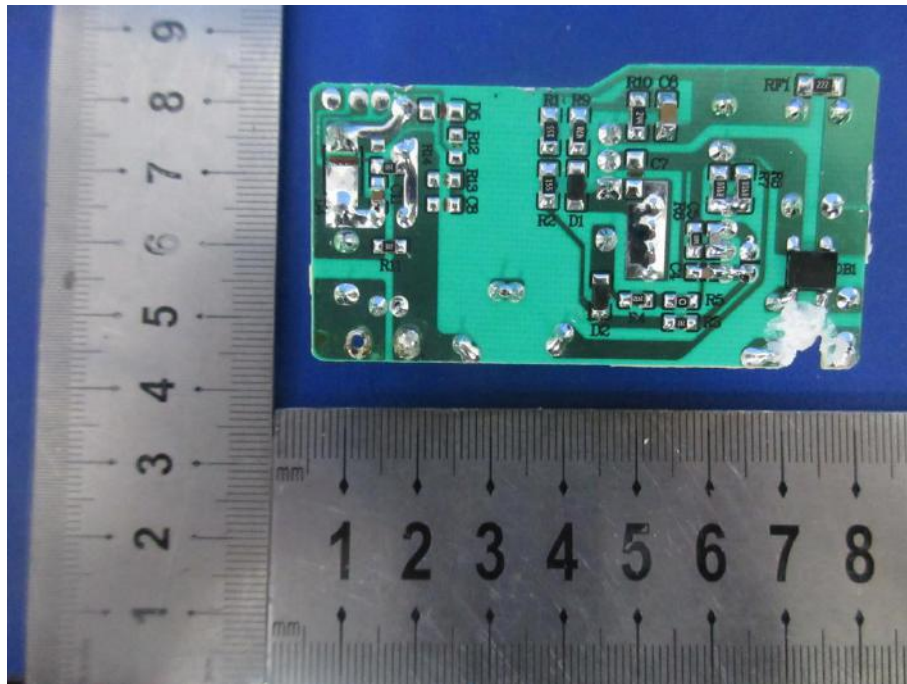

*** End of Report ***

声明 Statement

1. 本报告无授权批准人签字及“检验报告专用章”无效；

This report will be void without authorized signature or special seal for testing report.

2. 未经许可本报告不得部分复制；

This report shall not be copied partly without authorization.

3. 本报告的检测结果仅对送测样品有效，委托方对样品的代表性和资料的真实性负责；

The test results or observations are applicable only to tested sample. Client shall be responsible for representativeness of the sample and authenticity of the material.

4. 本检测报告中检测项目标注有特殊符号则该项目不在资质认定范围内，仅作为客户委托、科研、教学或内部质量控制等目的使用；

The observations or tests with special mark fall outside the scope of accreditation, and are only used for purpose of commission, research, training, internal quality control etc.

5. 本检测报告以实测值进行符合性判定，未考虑不确定度所带来的风险，本实验室不承担相关责任，特别约定、标准或规范中有明确规定的除外；

The test results or observations are provided in accordance with measured value, without taking risks caused by uncertainty into account. Without explicit stipulation in special agreements, standards or regulations, EMTEK shall not assume any responsibility.

6. 对本检测报告若有异议，请于收到报告之日起 20 日内提出；

Objections shall be raised within 20 days from the date receiving the report.